

FUTURA

Design HANGAR DESIGN GROUP SRL

FUTURA LT M

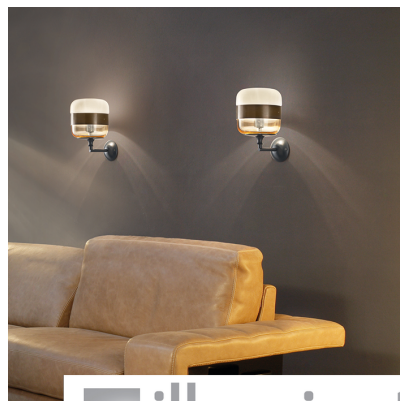
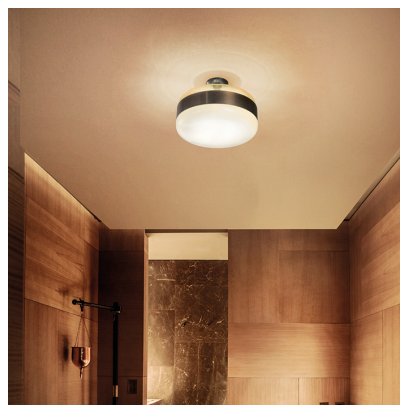

Collection of lamps in blown glass available in three exclusive colors combined with different finishes of the metal ring. The glass is blown in one piece but the particular handcraft process makes the colour transparent in the upper part and diffuser in the bottom part.

FUTURA LT M

TECHNICAL DATA:

CERTIFICATIONS:

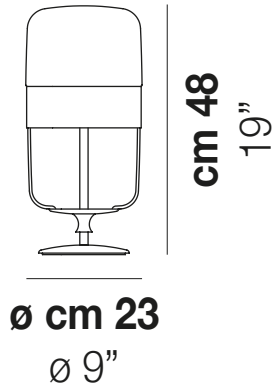

LIGHT SOURCES

E26  1x60w 120V/60HZ E26

VOLUME Mc 0,16
GROSS WEIGHT Kg 0
NET WEIGHT Kg 0

download



SHADE FINISHING



AM/OT

BC/NE

CR/RA

FU/MA

FRAME FINISHING

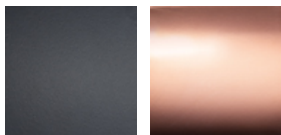

NE

RA

OTHER VERSION AVAILABLE

Click on the version to go to the web version of the product



FUTUR LT P

FUTURA

Design HANGAR DESIGN GROUP SRL

FUTURA LT P

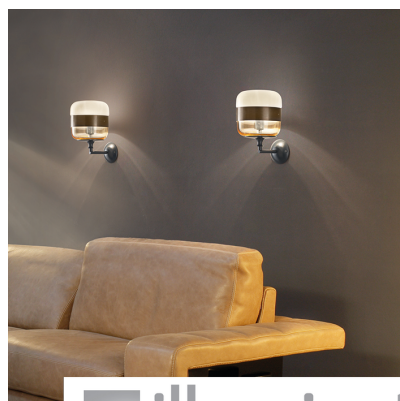
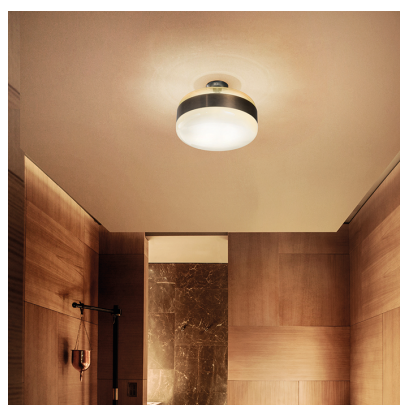

Collection of lamps in blown glass available in three exclusive colors combined with different finishes of the metal ring. The glass is blown in one piece but the particular handcraft process makes the colour transparent in the upper part and diffuser in the bottom part.

FUTURA LT P

TECHNICAL DATA:

CERTIFICATIONS:

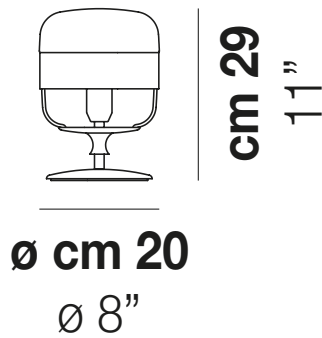

LIGHT SOURCES

E26  1x60w 120V/60HZ E26

VOLUME Mc 0,16
GROSS WEIGHT Kg 0
NET WEIGHT Kg 0

download



SHADE FINISHING



AM/OT

BC/NE

CR/RA

FU/MA

FRAME FINISHING

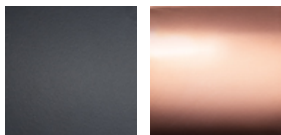

NE

RA

OTHER VERSION AVAILABLE

Click on the version to go to the web version of the product

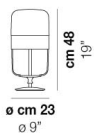

FUTUR LT M