

Tube

Design by Ichiro Iwasaki

VIBIA

Tube is a modular pendant and ceiling system with numerous possibilities. Composed of four different size of shades and a black tube that can grow in vertical and horizontal as desired, to bring the light where it is needed in groupings that are integrated with the architecture of the spaces where they are featured.

References:

6100. 6105. 6110. 6115.

Application:

Ceiling Lamp.

Installation type:

Surface.

Diffuser:

Polycarbonate.



Materials:

Diffuser: Polycarbonate
LED support: Aluminum
Shade: Aluminum
Canopy: Steel.

Finish:

Ref. 6100, 6105, 6110.

- 10 White (NCS S 0300-N)
- 15 Grey L2 (NCS S 2500-N)
- 16 Grey M1 (NCS S 4500-N)
- 21 Grey D1 (NCS S 7000-N)

Ref. 6115.

- 10 White (NCS S 0300-N)
- 71 Grey L2, Grey M1, Grey D1 (NCS S 2500-N, NCS S 4500-N, NCS S 7000-N)

Dimming: 0-10V.

Personalization options available

- Configuration layout at vibia.com
 - LED 3500 K.
 - Dimming: DALI, Lutron Eco
- Min. quantity, upcharge and extra lead time apply.

Installation and assembly:

Please, see the installation manual.

www.vibia.com ► Professional area

and together with the product you'll receive a personalized installation guide with all the details of your composition and guidance for its correct and easy installation.

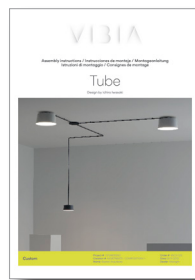

Light distribution:

Accent lighting: Fixtures providing down light to highlight a specific area or element.



Certificates:



425 Peachtree Hills Ave. NE #3 Atlanta, GA 30305
404.876.1064
sales@illumco.com

Tube

Design by Ichiro Iwasaki

VIBIA



6100

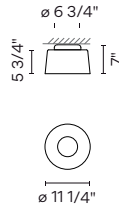

1 x LED PLATE 13.5W 700mA.
LED 2700 K. CRI >90. 1740 lm. 128.9 lm/W.
Driver Constant Current 700 mA.
 120-277V. 50/60Hz.
Dimming: 0-10V.

Installation type: Surface.

Personalization options available
 - Configuration layout at vibia.com
 - LED 3500 K.
 - Dimming: DALI, Lutron Eco
 Min. quantity, upcharge and extra lead time apply.

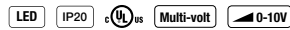

6105

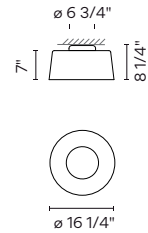

1 x LED PLATE 20W 700mA.
LED 2700 K. CRI >90. 2900 lm. 145 lm/W.
Driver Constant Current 700 mA.
 120-277V. 50/60Hz.
Dimming: 0-10V.

Installation type: Surface.

Personalization options available
 - Configuration layout at vibia.com
 - LED 3500 K.
 - Dimming: DALI, Lutron Eco
 Min. quantity, upcharge and extra lead time apply.

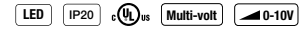

6110

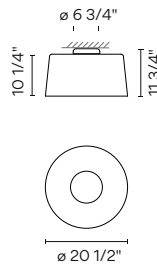

1 x LED PLATE 20W 700mA.
LED 2700 K. CRI >90. 2900 lm. 145 lm/W.
Driver Constant Current 700 mA.
 120-277V. 50/60Hz.
Dimming: 0-10V.

Installation type: Surface.

Personalization options available
 - Configuration layout at vibia.com
 - LED 3500 K.
 - Dimming: DALI, Lutron Eco
 Min. quantity, upcharge and extra lead time apply.



6115

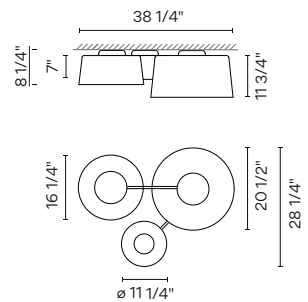

1 x LED PLATE 13.5W 700mA.
 2 x LED PLATE 20W 700mA.
LED 2700 K. CRI >90. 7540 lm. 140.9 lm/W.
Driver Constant Current 700 mA.
 120-277V. 50/60Hz.
Dimming: 0-10V.

Installation type: Surface.

Personalization options available

- Configuration layout at vibia.com
 - LED 3500 K.
 - Dimming: DALI, Lutron Eco
 Min. quantity, upcharge and extra lead time apply.

VIBIA, INC.

USA & CANADA
 272 Fernwood Ave.
 Edison, NJ 08837. USA
 Phone 732 417 1700.

HEADQUARTERS
 Progrés 4-6
 08850 Gavà
 Barcelona, Spain

425 Peachtree Hills Ave. NE #3 Atlanta, GA 30305
 404.876.1064 sales@illumco.com

Tube

Design by Ichiro Iwasaki

VIBIA



Tube is a modular pendant and ceiling system with numerous possibilities. Composed of four different size of shades and a black tube that can grow in vertical and horizontal as desired, to bring the light where it is needed in groupings that are integrated with the architecture of the spaces where they are featured.

References:

6120. 6125. 6130. 6135. 6145. 6155.

Application:

Hanging Lamps.

Installation type:

Surface.

Diffuser:

Polycarbonate.

Materials:

Diffuser: Polycarbonate.

Shade: Aluminum.



Led support: Aluminum.

Tube: Steel. Black finish.



Canopy: Steel.

Finish:

Ref. 6120, 6125, 6130, 6135.

-  10 White (NCS S 0300-N)
-  15 Grey L2 (NCS S 2500-N)
-  16 Grey M1 (NCS S 4500-N)
-  21 Grey D1 (NCS S 7000-N)

Ref. 6140, 6145, 6150, 6155.

-  10 White (NCS S 0300-N)
-   71 Grey L2, Grey M1, Grey D1 (NCS S 2500-N, NCS S 4500-N, NCS S 7000-N)

Dimming: 0-10V.

Personalization options available

- Configuration layout at vibia.com
 - LED 3500 K.
 - Dimming: DALI, Lutron Eco
- Min. quantity, upcharge and extra lead time apply.

Installation and assembly:

Please, see the installation manual.

www.vibia.com ► Professional area

and together with the product you'll receive a personalized installation guide with all the details of your composition and guidance for its correct and easy installation.



Light distribution:

Accent lighting: Fixtures providing down light to highlight a specific area or element.



Certificates:



425 Peachtree Hills Ave. NE #3 Atlanta, GA 30305
404.876.1064 sales@illumco.com

Tube

Design by Ichiro Iwasaki

VIBIA



6120

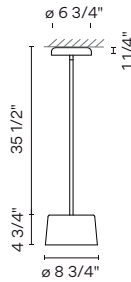

1 x LED PLATE 10.5W 700mA.
LED 2700 K. CRI >90. 1450 lm. 138 lm/W.
Driver Constant Current 700 mA.
 120-277V. 50/60Hz.
Dimming: 0-10V.

Installation type: Surface.

Personalization options available

- Configuration layout at vibia.com
 - LED 3500 K.
 - Dimming: DALI, Lutron Eco
- Min. quantity, upcharge and extra lead time apply.

Stem not field adjustable; personalized lengths must be ordered through vibia.com

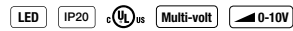

6125

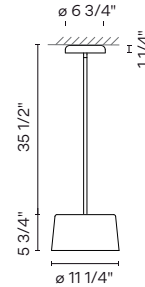

1 x LED PLATE 13.5W 700mA.
LED 2700 K. CRI >90. 1740 lm. 128,9 lm/W.
Driver Constant Current 700 mA.
 120-277V. 50/60Hz.
Dimming: 0-10V.

Installation type: Surface.

Personalization options available

- Configuration layout at vibia.com
 - LED 3500 K.
 - Dimming: DALI, Lutron Eco
- Min. quantity, upcharge and extra lead time apply.

Stem not field adjustable; personalized lengths must be ordered through vibia.com



6130

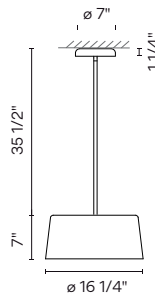

1 x LED PLATE 20W 700mA.
LED 2700 K. CRI >90. 2900 lm. 145 lm/W.
Driver Constant Current 700 mA.
 120-277V. 50/60Hz.
Dimming: 0-10V.

Installation type: Surface.

Personalization options available

- Configuration layout at vibia.com
 - LED 3500 K.
 - Dimming: DALI, Lutron Eco
- Min. quantity, upcharge and extra lead time apply.

Stem not field adjustable; personalized lengths must be ordered through vibia.com



6135

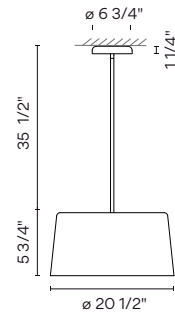

1 x LED PLATE 20W 700mA.
LED 2700 K. CRI >90. 2900 lm. 145 lm/W.
Driver Constant Current 700 mA.
 120-277V. 50/60Hz.
Dimming: 0-10V.

Installation type: Surface.

Personalization options available

- Configuration layout at vibia.com
 - LED 3500 K.
 - Dimming: DALI, Lutron Eco
- Min. quantity, upcharge and extra lead time apply.

425 Peachtree Hills Ave. NE #3 Atlanta, GA 30305
 404.876.1064 sales@illumco.com