

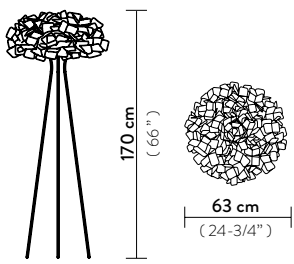

CLIZIA FLOOR / TABLE

design by Adriano Rachele

Compendium page 174

PRODUCT	SIZE	COLOUR	CODE
<p>FLOOR LAMP</p> <p>Bulbs E27:</p> <p> 3 X 8W LED Filament</p> <p>Made of: Opalflex® / Lentiflex® - Cristalflex Fumé®</p> <p>With: MagneticSystem®</p> <p>Weight: net Kg 7,05 - gross Kg 11,6</p> <p>Package: A 6,9kg 159 x 32 x h13 cm B 4,7kg 80 x 80 x h25 cm</p>	 <p>170 cm (66")</p> <p>63 cm (24-3/4")</p>	<p><input type="checkbox"/> WHITE</p> <p><input checked="" type="checkbox"/> BLACK</p> <p><input type="checkbox"/> PURPLE</p> <p><input type="checkbox"/> FUMÉ</p>	<p>CLI78PST0000W_000</p> <p>CLI78PST0000N_000</p> <p>CLI78PST0000P_000</p> <p>CLI78PST0000F_000</p>

CE IP 20  

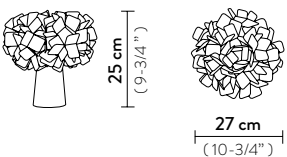
<p>TABLE LAMP</p> <p>Bulbs E14:</p> <p> 1 X 4W LED Filament</p> <p>Made of: Lentiflex® / Cristalflex Fumé®</p> <p>With: MagneticSystem® Coloured steel base</p> <p>Weight: net Kg 0,45 - gross Kg 0,85</p> <p>Package: 28 x 28 x h28 cm</p>	 <p>25 cm (9-3/4")</p> <p>27 cm (10-3/4")</p>	<p><input checked="" type="checkbox"/> BLACK</p> <p><input type="checkbox"/> WHITE</p> <p><input type="checkbox"/> ORANGE</p> <p><input type="checkbox"/> PURPLE</p> <p><input type="checkbox"/> FUMÉ</p>	<p>CLI78TAV0001N_000</p> <p>CLI78TAV0001W_000</p> <p>CLI78TAV0001A_000</p> <p>CLI78TAV0001H_000</p> <p>CLI78TAV0001F_000</p>
---	--	---	--

CE IP 20  

CLIZIA ENTIRE COLLECTION

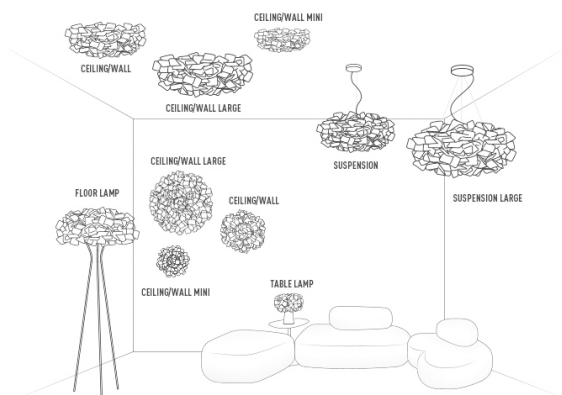

ENERGY CLASS

This luminaire is compatible with bulbs of the energy classes:

SLAMP: CLIZIA FLOOR

874/2012

This luminaire is compatible with bulbs of the energy classes:







SLAMP: CLIZIA TABLE

874/2012

CLIZIA TABLE FUMÉ BATTERY

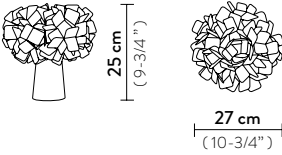
design by Adriano Rachele

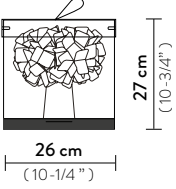
New Clizia Table Battery Powered Catalogue

PRODOTTO	MISURE	COLORI	CODICE
<p>TABLE LAMP</p> <p>Light source: 3W LED - 550 Lumen - 2900 Kelvin Recargable Li-ion battery 7 hours operating time</p> <p>Made of: Lentiflex® / Cristalflex Fumé® With: USB / DC plug included</p> <p>Weight: net Kg 0,45 - gross Kg 0,85 Package: 28 x 28 x h28 cm</p> <p>CE IP 20  </p>	  	<p> FUMÉ</p> <p> FUMÉ TRANSP. BOX</p>	<p>CLI78TAVB0C1F_000</p> <p>CLI78TAVB001F_000</p>

CLIZIA BATTERY ENTIRE COLLECTION

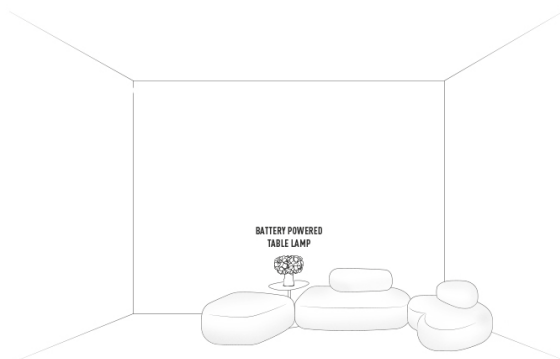



ENERGY CLASS

 This luminaire contains built-in LED lamps.

The lamp cannot be changed in the luminaire.

SLAMP: CLIZIA BATTERY

 LED

 874/2012