

CERAUNAVOLTA suspension lamp 22 elements

Matteo Ugolini & Edmondo Testaguzza design

year 2016

DATA SHEET - **SE134 1S 00D**

LAMPSHADE "A"

material glass
colour transparent



CEILING CUP "E"

material metal
colour matt white

ELECTRICAL CABLE "C"

colour transparent



SUSPENSION CABLE "F"

material metal

PACKAGING

net weight/kg 16,6

ELECTRICAL SYSTEM

socket E27
source 4 x max 20W LED
energy class from A to A++

LIGHT EMISSION

unidirectional

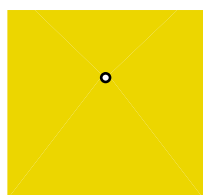

direct
filtered
indirect
absence

COMPLIANT WITH

IEC 60598-1:2014
EN 60598-1:2015



degree of protection IP20
bulb not provided

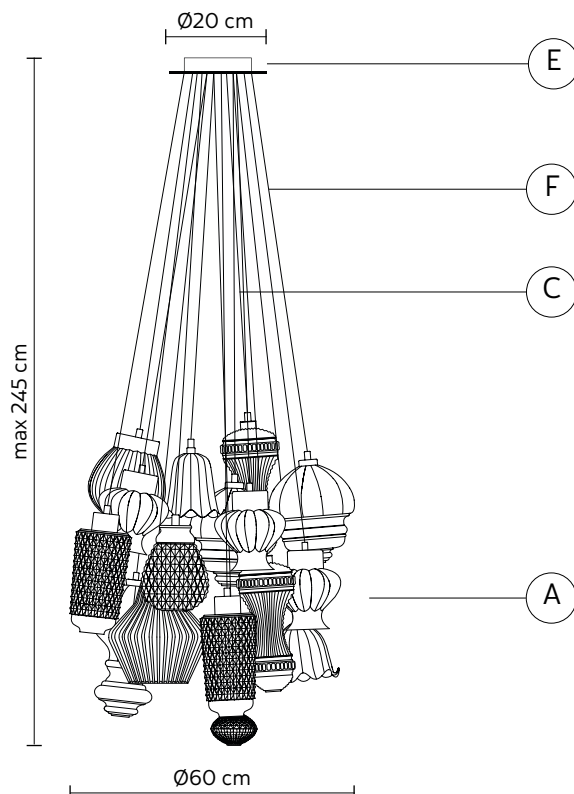

COLLECTION

also available modular/single version
suspension lamp and transparent colour



SE134 2S 00A



SE134 2T 00A



SE134 3S 00C



SE134 3T 00C



SE134 1T 00D

 **illuminations**
425 Peachtree Hills Ave. NE #3 Atlanta, GA 30305
404.876.1064 sales@illumco.com

CERAUNAVOLTA suspension lamp 22 elements

Matteo Ugolini & Edmondo Testaguzza design

year 2018

DATA SHEET - SE134 1T 00D

LAMPSHADE "A"

material glass
colour tiffany



CEILING CUP "E"

material metal
colour matt white

ELECTRICAL CABLE "C"

colour transparent



SUSPENSION CABLE "F"

material metal

PACKAGING

net weight/kg 16,6

ELECTRICAL SYSTEM

socket E27
source 4 x max 20W LED
energy class from A to A++

LIGHT EMISSION

unidirectional

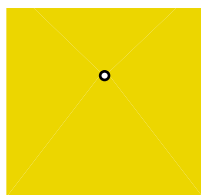

direct
filtered
indirect
absence

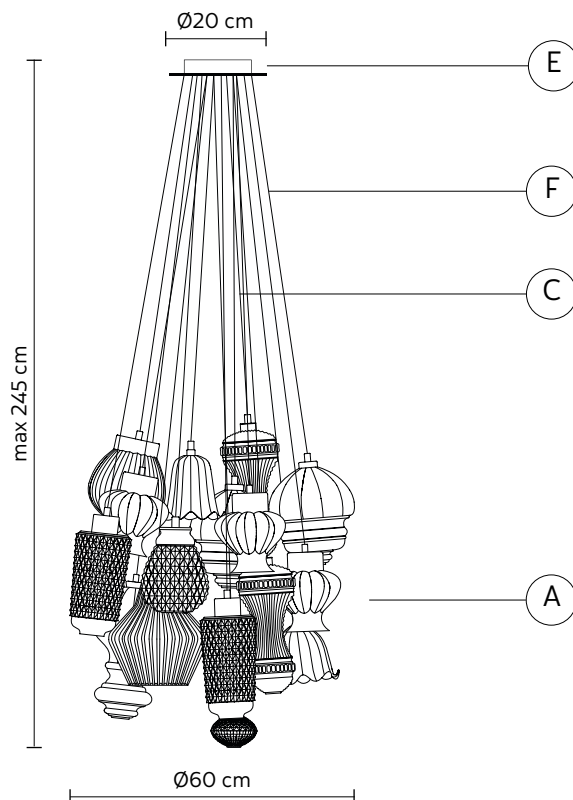

COMPLIANT WITH

IEC 60598-1:2014
EN 60598-1:2015



degree of protection IP20
bulb not provided

COLLECTION

also available modular/single version
suspension lamp and transparent colour



SE134 2S 00A



SE134 2T 00A



SE134 3S 00C



SE134 3T 00C



SE134 1S 00D

 **illuminaTions**
425 Peachtree Hills Ave. NE #3 Atlanta, GA 30305
404.876.1064 sales@illumco.com

CERAUNAVOLTA suspension lamp 12 elements

Matteo Ugolini & Edmondo Testaguzza design

year 2016

DATA SHEET - SE134 2S 00A

LAMPSHADE "A"

material	glass	
colour	transparent	

CEILING CUP "E"

material	metal
colour	matt white

ELECTRICAL CABLE "C"

colour	transparent	
--------	-------------	---

SUSPENSION CABLE "F"

material	metal
----------	-------

PACKAGING

net weight/kg	9,2
---------------	-----

ELECTRICAL SYSTEM

socket	E27
source	3 x max 20W LED
energy class	from A to A++

LIGHT EMISSION

unidirectional

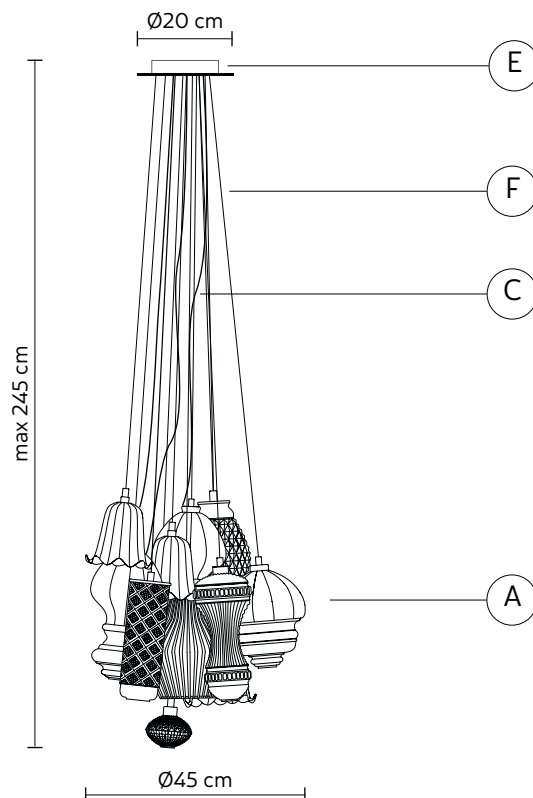

COMPLIANT WITH

IEC	60598-1:2014
EN	60598-1:2015



degree of protection bulb	IP20 not provided
---------------------------	----------------------

COLLECTION

also available modular/single version suspension lamp and tiffany colour

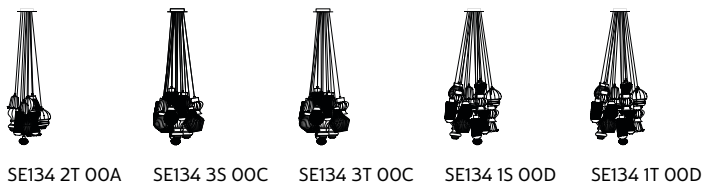

 **illuminations**
425 Peachtree Hills Ave. NE #3 Atlanta, GA 30305
404.876.1064 sales@illumco.com

CERAUNAVOLTA suspension lamp 12 elements

Matteo Ugolini & Edmondo Testaguzza design

year 2018

DATA SHEET - SE134 2T 00A

LAMPSHADE "A"

material glass
colour tiffany



CEILING CUP "E"

material metal
colour matt white

ELECTRICAL CABLE "C"

colour transparent



SUSPENSION CABLE "F"

material metal

PACKAGING

net weight/kg 9,2





ELECTRICAL SYSTEM

socket E27
source 3 x max 20W LED
energy class from A to A++

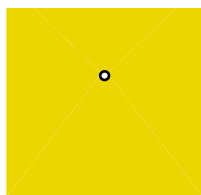
LIGHT EMISSION

unidirectional



 direct
 filtered
 indirect
 absence

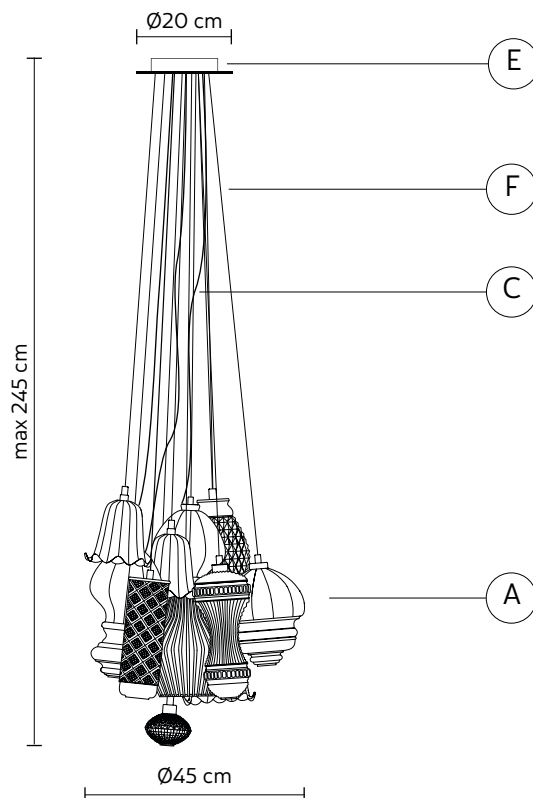

COMPLIANT WITH

IEC 60598-1:2014
EN 60598-1:2015



degree of protection IP20
bulb not provided

COLLECTION

also available modular/single version
suspension lamp and transparent colour



SE134 2S 00A



SE134 3S 00C



SE134 3T 00C



SE134 1S 00D



SE134 1T 00D

425 Peachtree Hills Ave. NE #3 Atlanta, GA 30305
404.876.1064
sales@illumco.com

CERAUNAVOLTA suspension lamp 17 elements

Matteo Ugolini & Edmondo Testaguzza design

year 2018

DATA SHEET - **SE134 3S 00C**

LAMPSHADE "A"

material	glass	
colour	transparent	

CEILING CUP "E"

material	metal
colour	matt white

ELECTRICAL CABLE "C"

colour	transparent	
--------	-------------	---

SUSPENSION CABLE "F"

material	metal
----------	-------

PACKAGING

net weight/kg	13
---------------	----

ELECTRICAL SYSTEM

socket	E27
source	3 x max 20W LED
energy class	from A to A++

LIGHT EMISSION

unidirectional

	 direct
	 filtered
	 indirect
	 absence

COMPLIANT WITH

IEC	60598-1:2014
EN	60598-1:2015

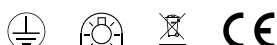

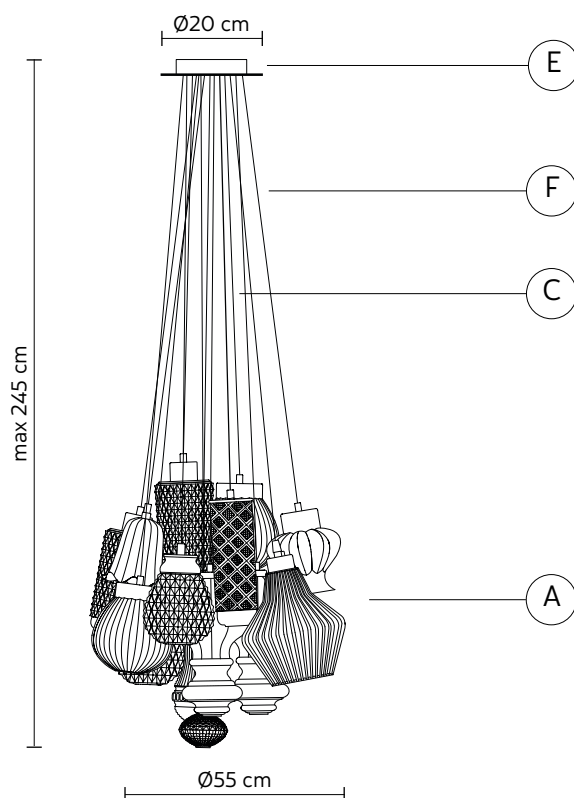

degree of protection bulb	IP20 not provided
---------------------------	----------------------

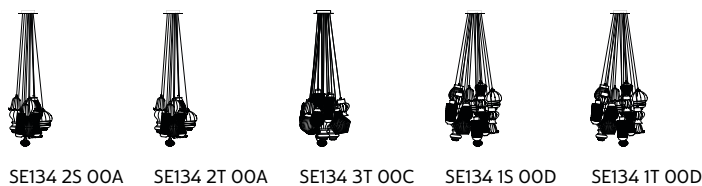

COLLECTION

also available modular/single version suspension lamp and tiffany colour



 **illuminaTIONS**
425 Peachtree Hills Ave. NE #3 Atlanta, GA 30305
404.876.1064 sales@illumco.com

CERAUNAVOLTA suspension lamp 17 elements

Matteo Ugolini & Edmondo Testaguzza design

year 2018

DATA SHEET - **SE134 3T 00C**

LAMPSHADE "A"

material glass
colour tiffany



CEILING CUP "E"

material metal
colour matt white

ELECTRICAL CABLE "C"

colour transparent



SUSPENSION CABLE "F"

material metal

PACKAGING

net weight/kg 13

ELECTRICAL SYSTEM

socket E27
source 3 x max 20W LED
energy class from A to A++

LIGHT EMISSION

unidirectional

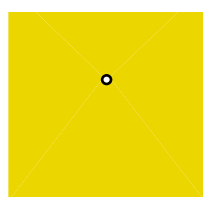

direct
filtered
indirect
absence

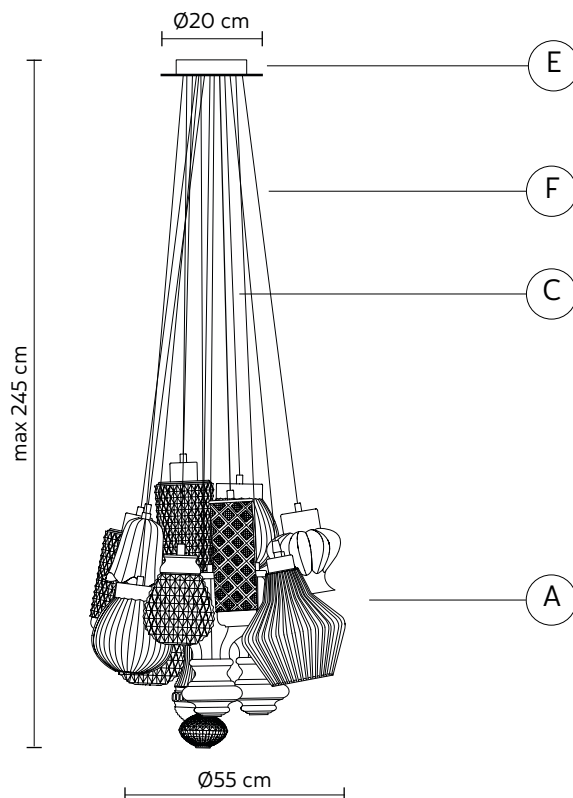

COMPLIANT WITH

IEC 60598-1:2014
EN 60598-1:2015



degree of protection IP20
bulb not provided

COLLECTION

also available modular/single version
suspension lamp and transparent colour

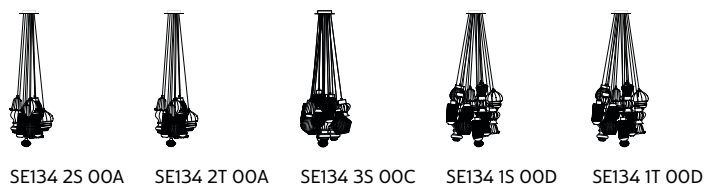

illuminations
425 Peachtree Hills Ave. NE #3 Atlanta, GA 30305
404.876.1064
sales@illumco.com