

CELL floor lamp

Matteo Ugolini design

year 2018

DATA SHEET - HP613 BM INT

LAMP "A"

material stainless steel
colour lacquered
glossy bronze



LAMPSHADE "B"

material linen
colour white



ELECTRICAL CABLE "C"

colour transparent



ELECTRICAL SYSTEM

socket E27
source 1 x max 70W
energy class from E to A++

PACKAGING

n° cartons 1
net weight/kg 13
gross weight/kg 16
packaging/cm 94x94x94

LIGHT EMISSION

unidirectional

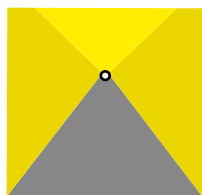

direct
filtered
indirect
absence

COMPLIANT WITH

IEC 60598-1:2014
EN 60598-1:2015



degree of protection IP20
bulb not provided

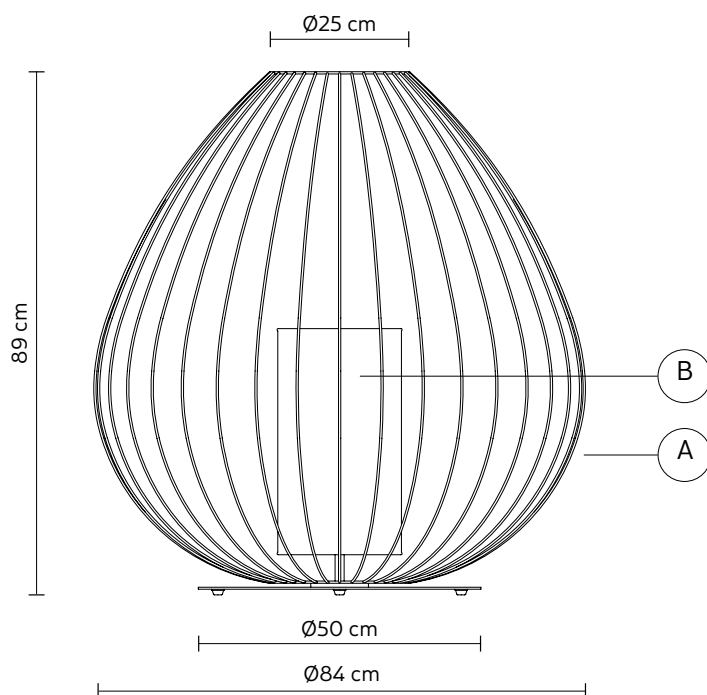

COLLECTION

also available suspension lamp version and in white color

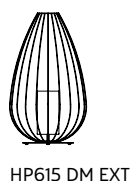

illuminations
425 Peachtree Hills Ave. NE #3 Atlanta, GA 30305
404.876.1064
sales@illumco.com

CELL table lamp

Matteo Ugolini design

year 2018

DATA SHEET - CT612 AM INT

LAMP "A"

material stainless steel
colour lacquered
glossy bronze



LAMPSHADE "B"

material linen
colour white



ELECTRICAL CABLE "C"

colour transparent



ELECTRICAL SYSTEM

socket E27
source 1 x max 52W
energy class from E to A++

PACKAGING

n° cartons 1
net weight/kg 5
gross weight/kg 6,5
packaging/cm 62x62x65

LIGHT EMISSION

unidirectional

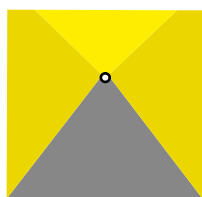

COMPLIANT WITH

IEC 60598-1:2014
EN 60598-1:2015



degree of protection IP20
bulb not provided

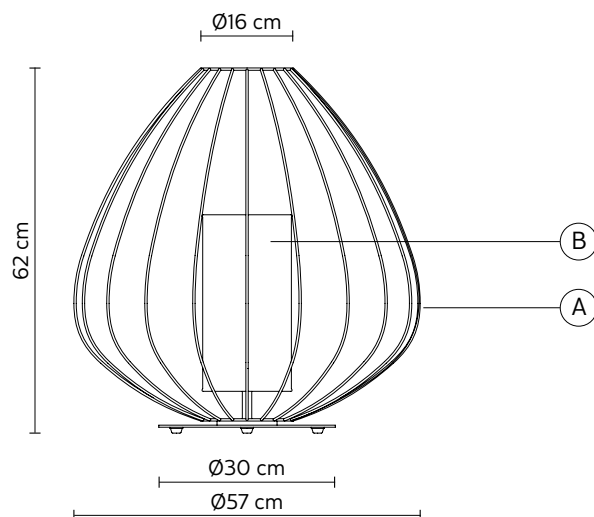

COLLECTION

also available suspension lamp version and in white color

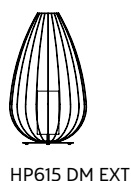
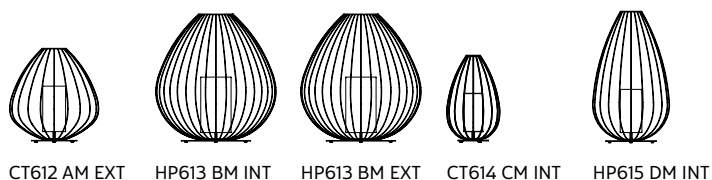

illuminations
425 Peachtree Hills Ave. NE #3 Atlanta, GA 30305
404.876.1064
sales@illumco.com

CELL table lamp

Matteo Ugolini design

year 2018

DATA SHEET - **CT614 CM INT**

LAMP "A"

material stainless steel
colour lacquered
glossy bronze



LAMPSHADE "B"

material linen
colour white



ELECTRICAL CABLE "C"

colour transparent

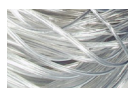

ELECTRICAL SYSTEM

socket E27
source 1 x max 52W
energy class from E to A++

PACKAGING

n° cartons 1
net weight/kg 2,5
gross weight/kg 3,5
packaging/cm 36x37x64

LIGHT EMISSION

unidirectional

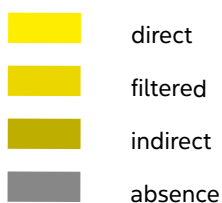
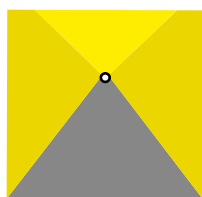

COMPLIANT WITH

IEC 60598-1:2014
EN 60598-1:2015



degree of protection IP20
bulb not provided

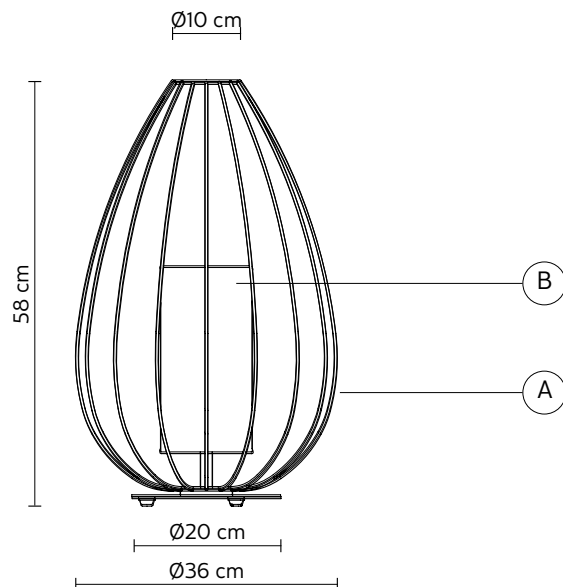

COLLECTION

also available suspension lamp version and in white color

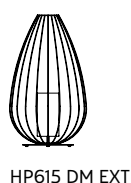
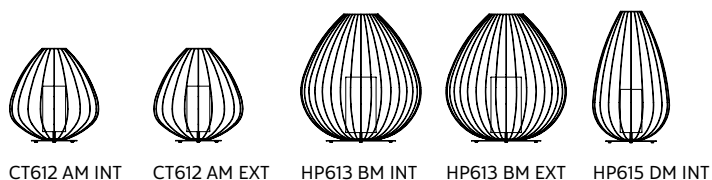

illuminations
425 Peachtree Hills Ave. NE #3 Atlanta, GA 30305
404.876.1064
sales@illumco.com

CELL floor lamp

Matteo Ugolini design

year 2018

DATA SHEET - HP615 DM INT

LAMP "A"

material stainless steel
colour lacquered
glossy bronze



LAMPSHADE "B"

material linen
colour white



ELECTRICAL CABLE "C"

colour transparent



ELECTRICAL SYSTEM

socket E27
source 1 x max 52W
energy class from E to A++

PACKAGING

n° cartons 1
net weight/kg 7,5
gross weight/kg 9,5
packaging/cm 57x57x93

LIGHT EMISSION

unidirectional

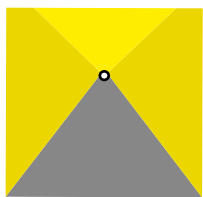

direct
filtered
indirect
absence

COMPLIANT WITH

IEC 60598-1:2014
EN 60598-1:2015



degree of protection IP20
bulb not provided

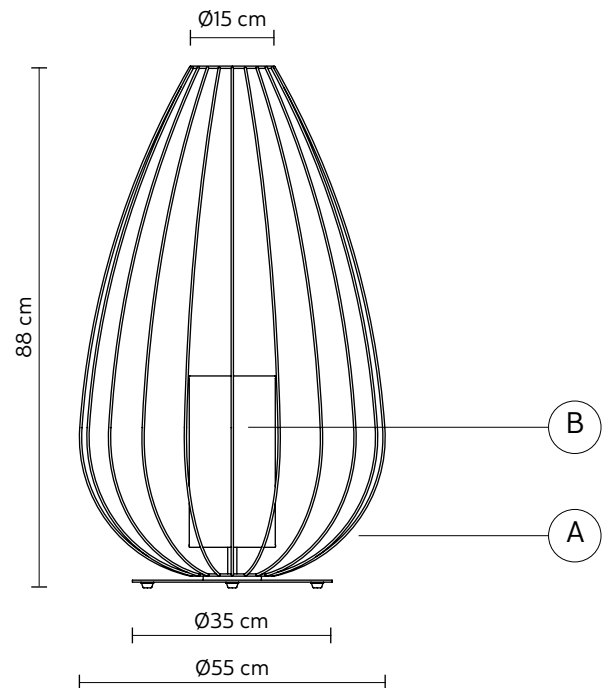

COLLECTION

also available suspension lamp version and in white color



CT612 AM INT



CT612 AM EXT

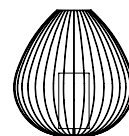

HP613 BM INT

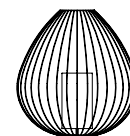

HP613 BM EXT



CT614 CM INT



HP615 DM EXT

 **illuminations**
425 Peachtree Hills Ave. NE #3 Atlanta, GA 30305
404.876.1064 sales@illumco.com

CELL table lamp

Matteo Ugolini design

year 2011

TECHNICAL SHEET - M612B

STRUCTURE "A"

material	steel inox	
colour	glossy white	

SHADE "B"

material	linen	
colour	white	

ELECTRICAL CABLE "C"

material	PVC	
colour	transparent	

ELECTRICAL SYSTEM

socket	E27
source	max 1x52w
energy class	from E to A++





PACKAGING

nr. of collis	1
net weight/kg	5
gross weight/kg	6,5
packaging/cm	62x62x65

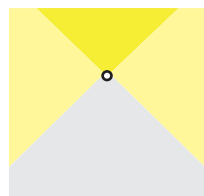
EMISSION OF LIGHT

one-directional



	direct
	filtered
	indirect
	none

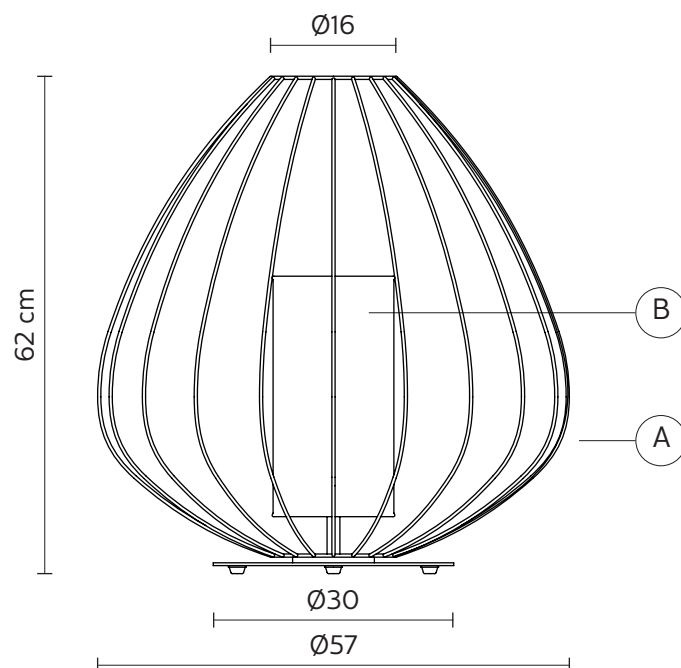





PACKAGING

nr. of collis	1
net weight/kg	5
gross weight/kg	6,5
packaging/cm	62x62x65

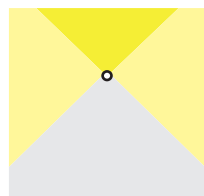
EMISSION OF LIGHT

one-directional



	direct
	filtered
	indirect
	none



CERTIFICATION

IEC	60598-1:2008
EN	60598-1:2008 + A11:2009



IP rate	IP20
bulb	not provided

COLLECTION

available also as: suspension (in/outdoor)

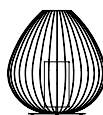

M613B



M614B



M615B



M612-EXT

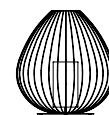

M613-EXT

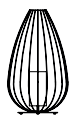

M615-EXT

425 Peachtree Hills Ave. NE #3 Atlanta, GA 30305
404.876.1064
sales@illumco.com

CELL floor lamp

Matteo Ugolini design

year 2011

TECHNICAL SHEET - M613B

STRUCTURE "A"

material	steel inox	
colour	glossy white	

SHADE "B"

material	linen	
colour	white	

ELECTRICAL CABLE "C"

material	PVC	
colour	transparent	

ELECTRICAL SYSTEM

socket	E27
source	max 1x70w
energy class	from E to A++





PACKAGING

nr. of collis	1
net weight/kg	13
gross weight/kg	16
packaging/cm	94x94x94

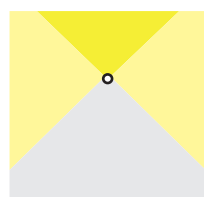
EMISSION OF LIGHT

one-directional



	direct
	filtered
	indirect
	none

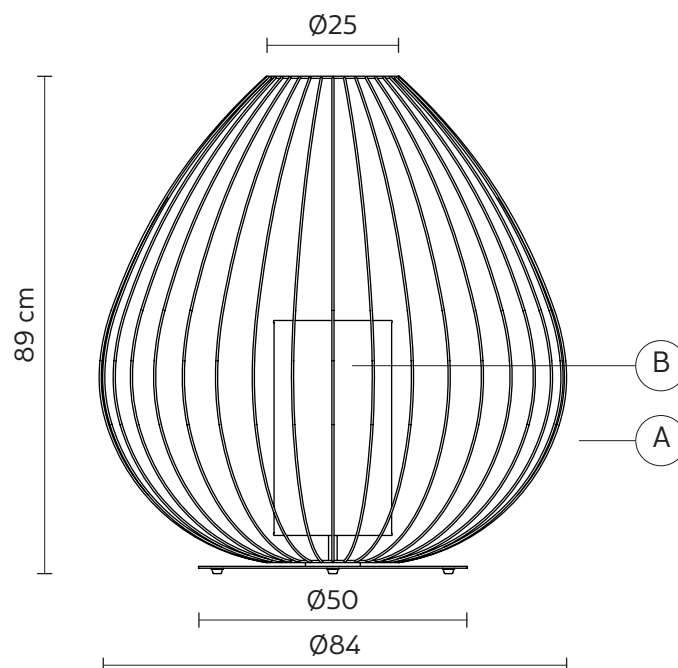

CERTIFICATION

IEC	60598-1:2008
EN	60598-1:2008 + A11:2009



IP rate	IP20
bulb	not provided

COLLECTION

available also as: suspension (in/outdoor)

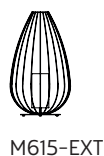

425 Peachtree Hills Ave. NE #3 Atlanta, GA 30305
404.876.1064 sales@illumco.com

CELL table lamp

Matteo Ugolini design

year 2009/2012

TECHNICAL SHEET - M614B

STRUCTURE "A"

material	steel inox	
colour	glossy white	

SHADE "B"

material	linen	
colour	white	

ELECTRICAL CABLE "C"

material	PVC	
colour	transparent	

ELECTRICAL SYSTEM

socket	E27
source	max 1x52w
energy class	from E to A++





PACKAGING

nr. of collis	1
net weight/kg	2,5
gross weight/kg	3,5
packaging/cm	36x37x64

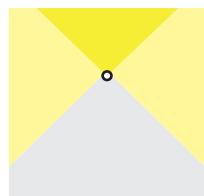
EMISSION OF LIGHT

one-directional



	direct
	filtered
	indirect
	none

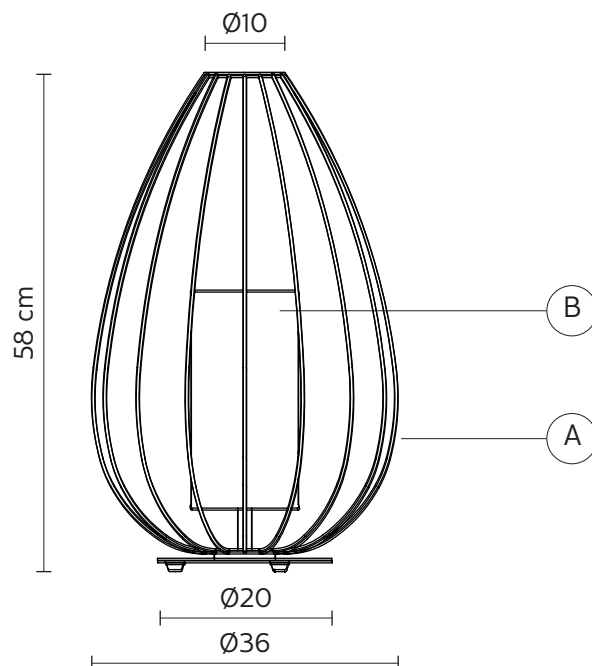

CERTIFICATION

IEC	60598-1:2008
EN	60598-1:2008 + A11:2009



IP rate	IP20
bulb	not provided

COLLECTION

available also as: suspension (in/outdoor)

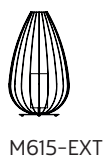

 **illuminations**
425 Peachtree Hills Ave. NE #3 Atlanta, GA 30305
404.876.1064 sales@illumco.com