

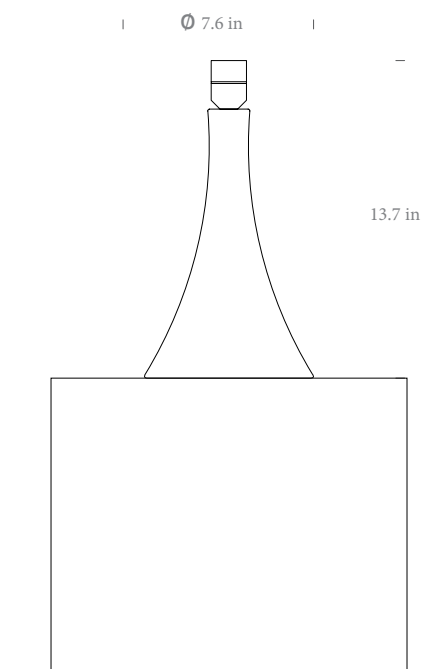

# Trumpet

A reassuringly classic shape, our Trumpet table base is available in three elegant finishes. Pair with a small round shade and fabric to suit.



**Trumpet 35**

**Materials :** Steel

**Colour :** White / Chrome / Brass

**Lightsource :** E27 Max 15W LED (not included)

**Cable :** 30cm to inline rocker switch, 1.5m to plug, Clear PVC cable

**Innermost recommends:**

Small round shades between 11.8 in and 15.7 in. Lighthouse with Ch is a particular favourite.



# Telford

Polyester

Our most versatile fabric, Telford, name after our home town, is available in 20 colours and looks great on all shapes and sizes.



Suitable for all shade shapes and sizes, see page 4 for details.

Materials : Woven Polyester

Acoustic Absorbancy : ●●○○○

Price category : A

Innermost recommends:

The ideal fabric for mixing and matching multiple colours.



# Harrogate

Quilted velvet

Add some luxury to your interior with these beautiful velvets available in five different coloured quilted patterns. The sumptuous quilting makes these fabrics extra thick and soft.

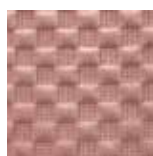

Pink  
Square



Grey  
Rectangles

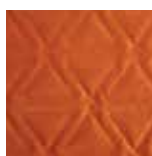

Burnt Orange  
Triangles



Blue  
Waves



Chocolate  
Tristar

Suitable for all Drum shapes  
Materials : Quilted velvet  
Acoustic Absorbancy : ●●●●●●  
Price category : C

Innermost recommends:  
Complete your pendant with a cotton diffuser.

 **illuminaTions**  
425 Peachtree Hills Ave. NE #3 Atlanta, GA 30305  
404.876.1064 sales@illumco.com





# Stafford

Polyethylene

This contemporary collection is taken from the world of contract wall-coverings. These earthy textural woven materials suit a natural colour palette.



Herringbone  
Tan

Herringbone  
Black

Red

Black

Dark Red

Blue

Suitable for all shade shapes and sizes, see page 4 for details.

Materials : Woven Polyester

Acoustic Absorbancy : ●●●●●

Fire Rated, Wipeable, Anti bac and Marine

Price category : C

Innermost recommends:

Being wipeable, Stafford is perfect for lampshades where cle



# Wenlock Wool felt

A soft natural wool felt in rich colours to bring added warmth to any interior.



Natural



Orange

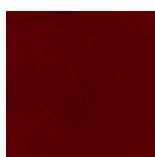

Red

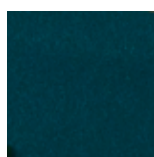

Ocean Blue

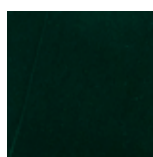

Dark Green



Navy



Charcoal

Suitable for all shade shapes and sizes, see page 4 for details.

Materials : Wool felt

Acoustic Absorbancy : ●●●●○

Price category : D

Innermost recommends:

Works well for both ceiling and table lamps to add texture to





# Creation Baumann Polyester

Création Baumann have been weaving world-renowned fabrics in Switzerland since 1886. We made this selection from their Arik collection as we believe they make great contemporary lampshades that will complement any interior. The fabric has a two-tone micro-pattern which results in an interplay with up to three colour nuances depending on the angle of vision.

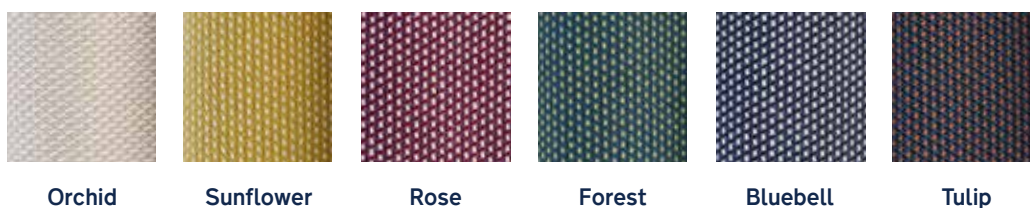

Orchid

Sunflower

Rose

Forest

Bluebell

Tulip

Suitable for all shade shapes and sizes, see page 4 for details.

Materials : Polyester

Acoustic Absorbancy : ●●●●●●

Price category : F

Innermost recommends:

Works best on large round & donut pendant and ceiling shapes.



**illuminaTions**

425 Peachtree Hills Ave. NE #3 Atlanta, GA 30305  
404.876.1064

sales@illumco.com





# Colefax Indra

Viscose polyester acrylic

A lustrous textured fabric from the British fabric house Colefax & Fowler that uses a satin warp and strong woven textures to achieve the effect of hammered metal. Polished and sleek, we have it as standard in 3 burnished tones of Copper, Teal and Silver.



Silver

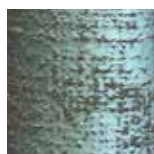

Teal

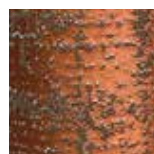

Copper

Suitable for all shade shapes and sizes, see page 4 for details.

Materials : Viscose Polyester Acrylic

Acoustic Absorbancy : ●●●●●●●●

Price category : G

Innermost recommends:

The sheen of these shades are perfect for adding sophisticated and low-key luxury.

 **illuminaTions**

425 Peachtree Hills Ave. NE #3 Atlanta, GA 30305  
404.876.1064

sales@illumco.com