



.ZERO CEILING

GENERAL INFO



IP65 e UL DAMP LOCATION su richiesta
On request IP65 and UL DAMP LOCATION

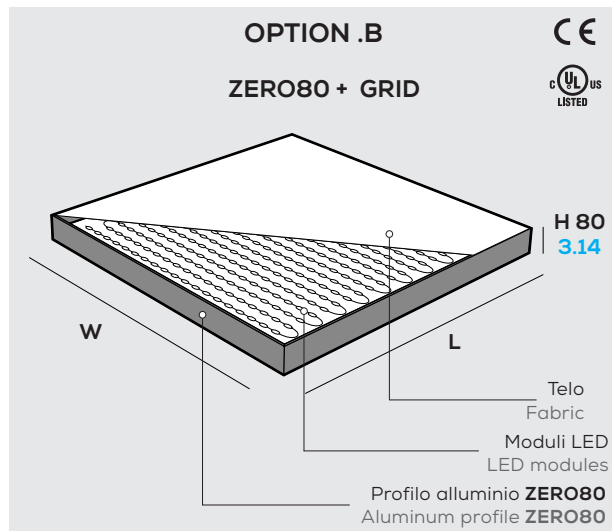
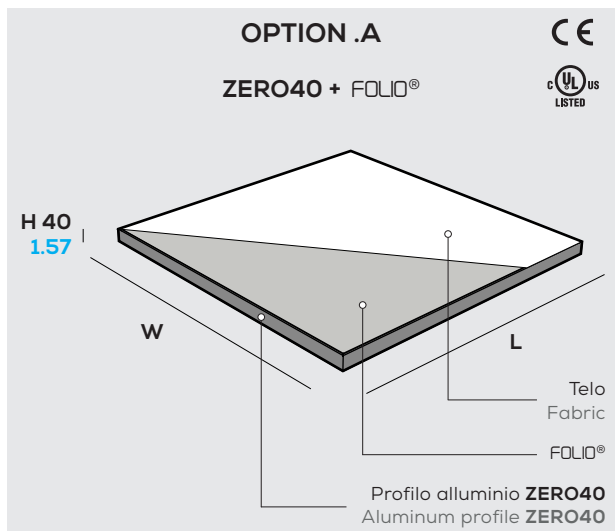

ZERO40 + FOLIO®

Zero a soffitto

Alluminio - Metacrilato - Telo

2700K / 3000K / 3500K / 4000K / 5700K / TW (24 V DC)

CRI > 90

Temperatura colore 2000K, 2200K, 2500K, 5000K, 6500K, RGB,

RGBW e RGBTW su richiesta

Nichia Optisolis™ (CRI 100) e Nichia Vitasolis™ su richiesta

ZERO40 + FOLIO®

Zero ceiling

Aluminum - Methacrylate - Fabric

2700K / 3000K / 3500K / 4000K / 5700K / TW (24 V DC)

CRI > 90

On request color temperature 2000K, 2200K, 2500K, 5000K,

6500K, RGB, RGBW and RGBTW

On request Nichia Optisolis™ (CRI 100) and Nichia Vitasolis™

ZERO80 + GRID

Zero a soffitto

Alluminio - Telo

3000K / 4000K / 5000K / 6500K / TW (24 V DC)

RGB (12 V DC)

CRI > 85

CCT 2700K su richiesta

ZERO80 + GRID

Zero ceiling

Aluminum - Fabric

3000K / 4000K / 5000K / 6500K / TW (24 V DC)

RGB (12 V DC)

CRI > 85

On request color temperature 2700K

Dimensioni

Sizes [mm] [in]

H	W	L
40 mm 1.57 in	1000 mm 39.37 in	1000 mm 39.37 in
40 mm 1.57 in	1000 mm 39.37 in	2000 mm 78.74 in
40 mm 1.57 in	1500 mm 59.05 in	1500 mm 59.05 in
40 mm 1.57 in	1500 mm 59.05 in	2500 mm 98.42 in

Altre dimensioni su richiesta. Variante sagomata su richiesta
Custom sizes available. On request shaped option

Dimensioni

Sizes [mm] [in]

H	W	L
80 mm 3.14 in	1000 mm 39.37 in	1000 mm 39.37 in
80 mm 3.14 in	1000 mm 39.37 in	2000 mm 78.74 in
80 mm 3.14 in	1500 mm 59.05 in	1500 mm 59.05 in
80 mm 3.14 in	1500 mm 59.05 in	2500 mm 98.42 in

Altre dimensioni su richiesta. Variante sagomata su richiesta
Custom sizes available. On request shaped option



.ZERO CEILING

GENERAL INFO

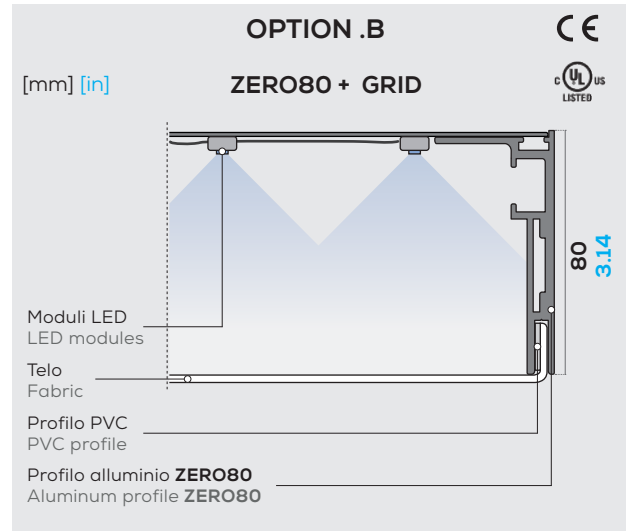
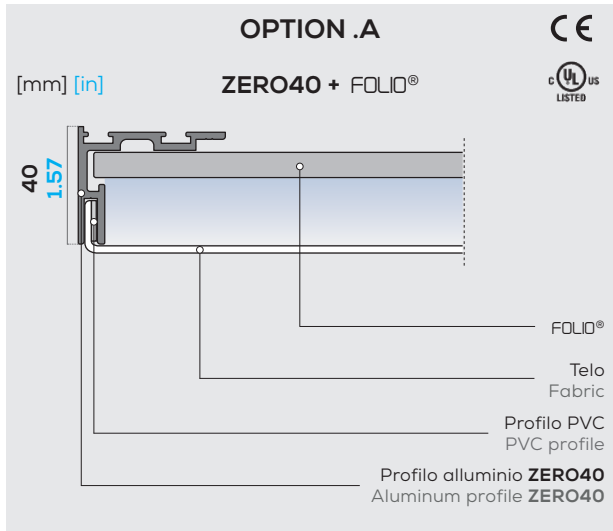

Finiture alluminio Aluminum finishings

Standard
Standard

- bianco
white
- nero
black
- ox argento
ox silver

Speciali
Special

-
- (esempi)
(examples)
-

Colori e finiture speciali alluminio su richiesta (vedi p. 292)
On request special aluminium colors and finishings (see p. 292)

Finiture alluminio Aluminum finishings

Standard
Standard

- bianco
white
- nero
black
- ox argento
ox silver

Speciali
Special

-
- (esempi)
(examples)
-

Colori e finiture speciali alluminio su richiesta (vedi p. 292)
On request special aluminium colors and finishings (see p. 292)

Tipologie telo Fabric options

Standard
Standard

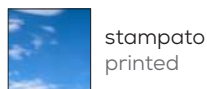

Speciali
Special

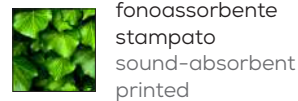
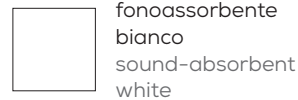

Tipologie speciali telo su richiesta (vedi pp. 292 - 293)
On request special fabric options (see pp. 292 - 293)

Tipologie telo Fabric options

Standard
Standard

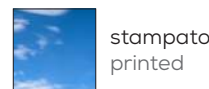

Speciali
Special

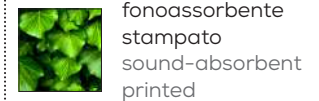
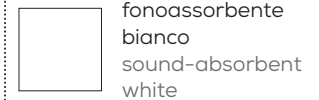

Tipologie speciali telo su richiesta (vedi pp. 292 - 293)
On request special fabric options (see pp. 292 - 293)

.ZERO CEILING

OPTION .A

LED Lifespan: L90 > 60.000 ore a 50° Celsius
 Blue Light risk group (200 mm): EXEMPT UNLIMITED
 Garanzia: 2 anni (disponibile estensione fino a 5 anni su richiesta)
 Input LED: 24 V DC
 Driver - Trasformatore: AC/DC 24 V

LED Lifespan: L90 > 60.000 hours at 50° Celsius
 Blue Light risk group (200 mm): EXEMPT UNLIMITED
 Warranty: 2 years (on request extension up to 5 years available)
 Input LED: 24 V DC
 Driver - Transformer: AC/DC 24 V



Temperatura colore Color temperature

- 2700 K
- 3000 K
- 3500 K
- 4000 K
- 5700 K
- Tunable White

CCT 2000K, 2200K, 2500K, 5000K, 6500K, RGB, RGBW e RGBTW su richiesta
 On request CCT 2000K, 2200K, 2500K, 5000K, 6500K, RGB, RGBW and RGBTW

Flusso luminoso output e potenza Luminous flux output and power

1000 x 1000 mm 39.37 x 39.37 in	P1 3500 lm P2 6300 lm	100 W 200 W
1000 x 2000 mm 39.37 x 78.74 in	P1 5250 lm P2 9450 lm	150 W 300 W
1500 x 1500 mm 59.05 x 59.05 in	P1 5250 lm P2 9450 lm	150 W 300 W
1500 x 2500 mm 59.05 x 98.42 in	P1 4000 lm P2 7000 lm	125 W 200 W

LIGHT INFO

OPTION .B

LED Lifespan: 50.000 ore

Garanzia: 2 anni (disponibile estensione fino a 5 anni su richiesta)
 Input LED: 24 V DC
 Driver - Trasformatore: AC/DC 24 V

LED Lifespan: 50.000 hours (only **OPTION .B**)

Warranty: 2 years (on request extension up to 5 years available)
 Input LED: 24 V DC
 Driver - Transformer: AC/DC 24 V



Temperatura colore Color temperature

- 3000 K
- 4000 K
- 5000 K
- 6500 K
- Tunable White
- RGB

CCT 2700K su richiesta
 On request CCT 2700K

Flusso luminoso output e potenza Luminous flux output and power

1000 x 1000 mm 39.37 x 39.37 in	G 2500 lm	35 W
1000 x 2000 mm 39.37 x 78.74 in	G 5625 lm	70 W
1500 x 1500 mm 59.05 x 59.05 in	G 6000 lm	80 W
1500 x 2500 mm 59.05 x 98.42 in	G 10000 lm	130 W

Su richiesta flusso e assorbimento luminoso personalizzabili
 Custom lumen output and luminous absorption available.

OPTION .A

OPTION .B

Polar diagram [cd/klm]

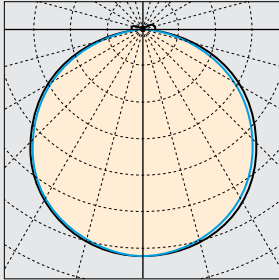

C180 — C270 — C0 — C90

Polar diagram [cd/klm]

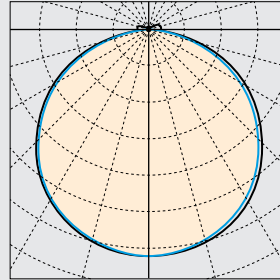

C180 — C270 — C0 — C90

UGR

$X = 4 H, Y = 8 H$

$S = 0.25 H$

Indici di riflessione
Reflectance indexes

70/ 50/ 20

.ZERO CEILING

UGR trasversale
UGR crosswise

UGR longitudinale
UGR endwise

1000 x 1000 mm
39.37 x 39.37 in

< 19

< 19

1000 x 2000 mm
39.37 x 78.74 in

< 19

< 19

1500 x 1500 mm
59.05 x 59.05 in

< 19

< 19

1500 x 2500 mm
59.05 x 98.42 in

< 19

< 19

Info LED
LED info

CRI $R_a = 100$ (*Nichia Optisolis™*) su richiesta
On request CRI $R_a = 100$ (*Nichia Optisolis™*)

CRI > 90

LED Nichia

Dimmerabile Si (vedi pp. 296 - 297)
Dimmable Yes (see pp. 296 - 297)

UGR

$X = 4 H, Y = 8 H$

$S = 0.25 H$

Indici di riflessione
Reflectance indexes

70/ 50/ 20

.ZERO CEILING

UGR trasversale
UGR crosswise

UGR longitudinale
UGR endwise

1000 x 1000 mm
39.37 x 39.37 in

< 19

< 19

1000 x 2000 mm
39.37 x 78.74 in

< 19

< 19

1500 x 1500 mm
59.05 x 59.05 in

< 19

< 19

1500 x 2500 mm
59.05 x 98.42 in

< 19

< 19

Info LED
LED info

CRI > 85

LED Nichia

Dimmerabile Si (vedi pp. 296 - 297)
Dimmable Yes (see pp. 296 - 297)

Nichia Optisolis™ e *Nichia Vitasolis™* su richiesta
On request *Nichia Optisolis™* and *Nichia Vitasolis™*

.ZERO CEILING

.ZERO40 + FOLIO®

Codice prodotto
Product code

[mm] [in]

prodotto product	dimensioni sizes	flusso luminoso luminous flux	CCT	finiture alluminio aluminium finishings	finitura telo fabric finishings	fissaggio fastening
Z40F option .A .ZERO40 + FOLIO®	10 1000 x 1000	P1 1 perimetro LED 1 LED perimeter	27 2700 K	W bianco white	WH bianco white	C a soffitto ceiling
	10 39.37 x 39.37					
	10 1000 x 2000	P2 2 perimetri LED 2 LED perimeters	30 3000 K	B nero black	PR stampato printed	
	20 39.37 x 78.74					
15 1500 x 1500	35 3500 K	O ox argento ox silver	SW fonoassorbente bianco sound-absorbent white			
15 59.05 x 59.05						
15 1500 x 2500	40 4000 K	S speciale ¹ special ¹	SP fonoassorbente stampato sound-absorbent printed			
25 59.05 x 98.42						
			57 5700 K			
			TW Tunable White			
			RQ su richiesta on request			

¹Finiture speciali su richiesta (vedi pp. 292 - 293)

¹On request special finishings (see pp. 292 - 293)

Dimensioni disponibili
Available sizes

[mm] [in]

1000 x 1000
39.37 x 39.37

1000 x 2000
39.37 x 78.74

1500 x 1500
59.05 x 59.05

1500 x 2500
59.05 x 98.42

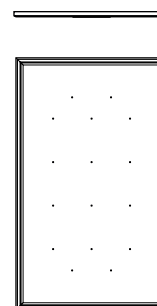
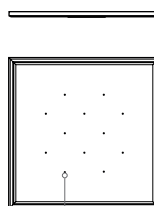
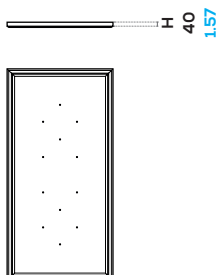
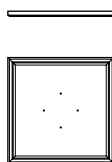

punti di fissaggio
fixing points

.ZERO CEILING

.ZERO80 + GRID

Codice prodotto
Product code

prodotto product		dimensioni sizes		flusso luminoso luminous flux		CCT		finiture alluminio aluminium finishings		finitura telo fabric finishings		fissaggio fastening	
Z80G	option .B	10	1000 x 1000	G	LED grid LED grid	-30	3000 K	W	bianco white	WH	bianco white	C	a soffitto ceiling
	.ZERO80 + GRID	10	39.37 x 39.37										
		10	1000 x 2000										
		20	39.37 x 78.74										
		15	1500 x 1500										
	15	59.05 x 59.05			-40	4000 K	B	nero black	PR	stampato printed			
		15	1500 x 2500			-50	5000 K	O	ox argento ox silver	SW	fonoassorbente bianco sound-absorbent white		
		25	59.05 x 98.42			-65	6500 K	S	speciale ¹ special ¹	SP	fonoassorbente stampato sound-absorbent printed		
						-TW	Tunable White						
						RGB	RGB						
						-RQ	su richiesta on request						

¹Finiture speciali su richiesta (vedi pp. 292 - 293)

¹On request special finishings (see pp. 292 - 293)

Dimensioni disponibili
Available sizes

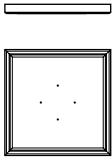
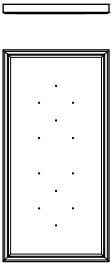
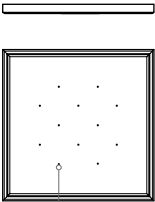
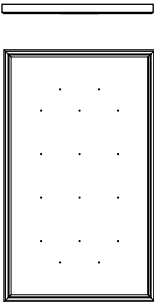
1000 x 1000		1000 x 2000		1500 x 1500		1500 x 2500	
	39.37 x 39.37		39.37 x 78.74		59.05 x 59.05		59.05 x 98.42
							
			H 80 3.14				
							punti di fissaggio fixing points

DETTAGLI E FINITURE DETAILS AND FINISHINGS

Finiture standard alluminio Standard aluminium finishings

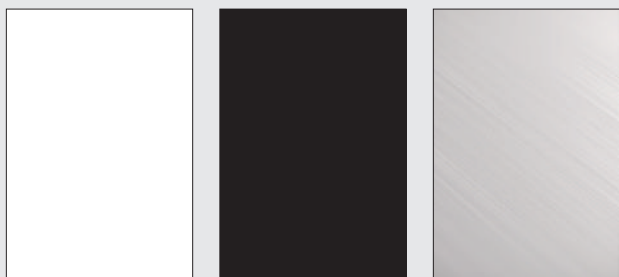

Bianco
White

Nero
Black

Ox argento
Ox silver

Dettagli sospensione Suspension details



Rosone
Ceiling rose

Terminale Zero
Zero terminal

Finiture speciali alluminio - verniciatura (esempi) Special aluminium finishings - liquid painting (e.g.)



Bronzo
Bronze

Ottone
Brass

RAL 3005

Rame
Copper

RAL 7035

RAL 7033

Finiture speciali alluminio - ossidazione (esempi) Special aluminium finishings - oxidation (e.g.)

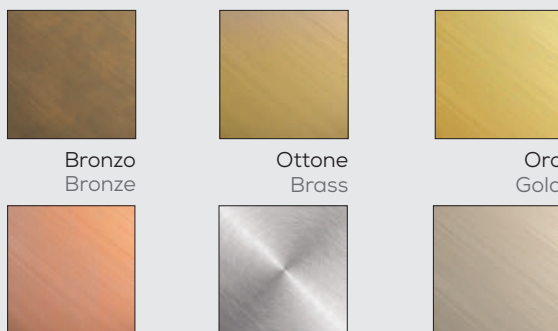

Bronzo
Bronze

Ottone
Brass

Oro
Gold

Rame
Copper

Cromato
Chrome

Champagne
Champagne

Tipologie standard telo Standard fabric options

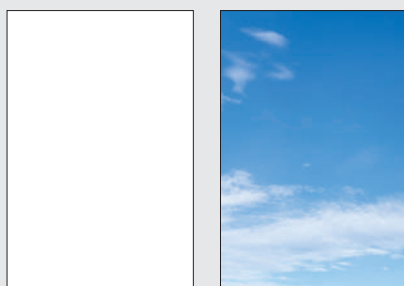

Bianco
White

Stampato
Printed

Tipologie speciali telo - fonoassorbente Special fabric options - sound-absorbed

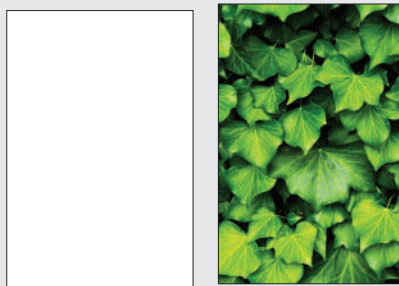

Bianco
White

Stampato
Printed

Tessuto in poliestere con proprietà acustiche. Tessuto fonoassorbente stampabile.

Polyester fabric with acustic properties. Printable sound-absorbent fabric.

TELO FONOASSORBENTE SOUND-ABSORBENT FABRIC

Tipologie speciali telo - fonoassorbente
Special fabric options - sound-absorbed

Tessuto in poliestere con proprietà acustiche.
Tessuto fonoassorbente stampabile.
Adatto per soffitti, anche di grandi dimensioni.
Spalmato posteriormente con poliuretano.
Ritardante di fiamma. Fornito con certificato acustico.
Retroilluminabile con LED e stampabile UV.

Polyester fabric with acoustic properties.
Printable sound-absorbent fabric.
Suitable for ceilings, also for big dimensions.
Back spread with polyurethane.
Flame retardant. Acoustic certificate provided.
UV printable and backlit with LED.



Composizione: 100% poliestere spalmato poliuretano
Filato poliestere
Peso (ISO 2286-2): 150 g/m³
Spessore: 0,35 mm
Altezza rotolo: 510 cm
Lunghezza rotolo: 35 m
Resistenza alla trazione - ordito (ISO 1421-1): 70Dan/5 cm
Resistenza alla trazione - trama (ISO 1421-1): 40 Dan/5 cm
Resistenza allo strappo - ordito (DIN 53363): 6,7 Dan
Resistenza allo strappo - trama (DIN 53363): 6,7 Dan
Classe di reazione al fuoco: M1 Bs1d0

Composition: 100% polyester back spread with polyurethane
Polyester thread
Weight (ISO 2286-2): 150 g/m³
Thickness: 0,35 mm
Roll height: 510 cm
Roll length: 35 m
Traction resistance - warp (ISO 1421-1): 70Dan/5 cm
Traction resistance - weave (ISO 1421-1): 40 Dan/5 cm
Tear resistance - warp (DIN 53363): 6,7 Dan
Tear resistance - weave (DIN 53363): 6,7 Dan
Class of reaction to fire: M1 Bs1d0

