



.FRAME SUSPENDED

GENERAL INFO



IP65 e UL DAMP LOCATION su richiesta
On request IP65 and UL DAMP LOCATION

Frame a sospensione
Alluminio - Metacrilato
2700K/ 3000K/ 3500K/ 4000K/ 5700K/ TW - CRI > 90
Temperature colore 2000K, 2200K, 2500K, 5000K, 6500K, RGB,
RGBW e RGBTW su richiesta
Nichia Optisolis™ (CRI 100) e *Nichia Vitasolis™* su richiesta

Frame suspended
Aluminum - Methacrylate
2700K/ 3000K/ 3500K/ 4000K/ 5700K/ TW - CRI > 90
On request color temperature 2000K, 2200K, 2500K, 5000K, 6500K,
RGB, RGBW and RGBTW
On request *Nichia Optisolis™* (CRI 100) and *Nichia Vitasolis™*

Finiture alluminio Aluminum finishings

Standard Standard	Speciali Special
<ul style="list-style-type: none"> ○ bianco white ● nero black 	<ul style="list-style-type: none"> ● ● (esempi) (examples) ● ●

Colori e finiture speciali alluminio su richiesta (vedi p. 156)
On request special aluminium colors and finishings (see p. 156)

Finiture opale Opal finishings

Standard Standard	Speciali Special
<ul style="list-style-type: none"> ○ lucido gloss ○ opaco matte 	<ul style="list-style-type: none"> opal milling opal sculpture

Finiture speciali opale su richiesta (vedi p. 159)
On request special opal finishings (see p. 159)

Dimensioni Sizes

W	H	L
100 mm 3.93 in	1000 mm 39.37 in	x 2000 mm 78.74 in
150 mm 5.90 in	1500 mm 59.05 in	x 2500 mm 98.42 in
200 mm 7.87 in	2000 mm 78.74 in	x 3000 mm 118.11 in

Altre dimensioni su richiesta
Custom sizes available

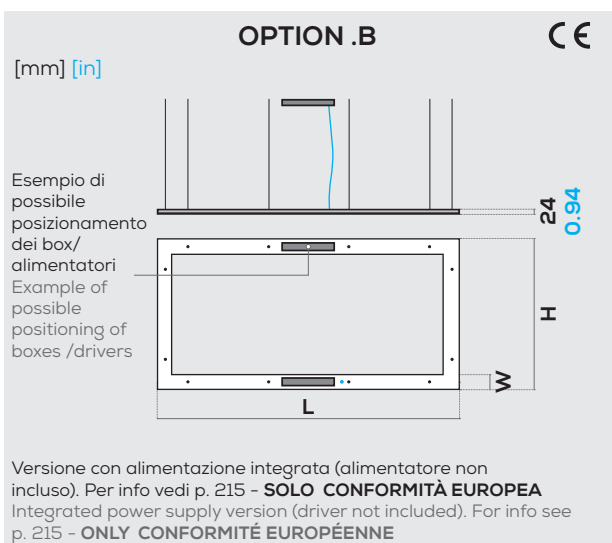
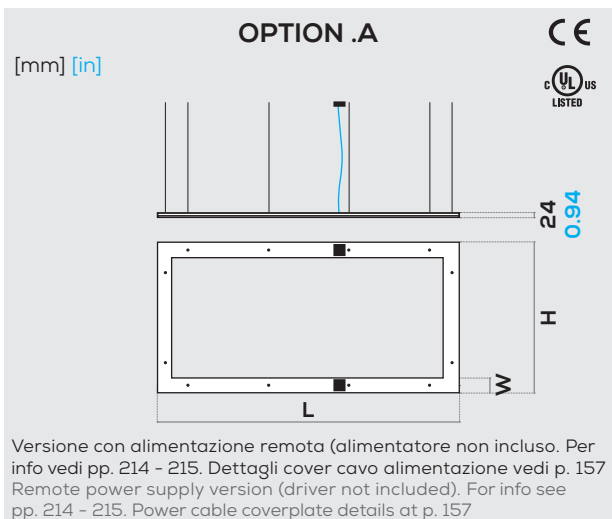

Installazione Installation

A sospensione
Suspended

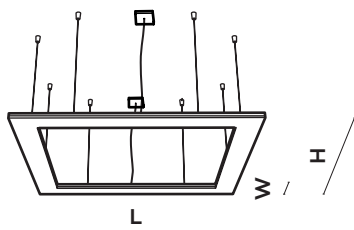



.FRAME SUSPENDED

Polar diagram [cd/klm]

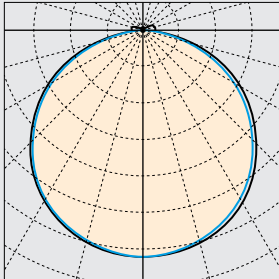

C180 — C270 — C0 — C90

UGR

X = 4 H, Y = 8 H

S = 0.25 H

Indici di riflessione
Reflectance indexes

70/ 50/ 20

.FRAME SUSPENDED

UGR trasversale
UGR crosswise

UGR longitudinale
UGR endwise

W 100 mm

1000 x 2000 mm

< 19

< 19

W 3.93 in

39.37 x 78.74 in

W 150 mm

1500 x 2500 mm

< 19

< 19

W 5.90 in

59.09 x 98.42 in

W 200 mm

2000 x 3000 mm

< 19

< 19

W 7.87 in

78.74 x 118.11 in

Posizione LED

LED position

P1

LED sul perimetro esterno
LED on the external perimeter

P2

LED sul perimetro esterno e interno
LED on the external and internal
perimeters

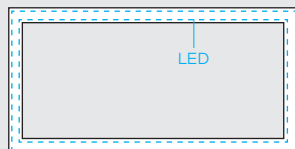
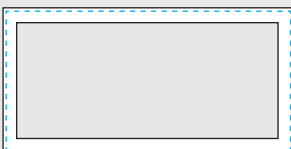

Nichia Optisolis™ e Nichia Vitasolis™ su richiesta
On request Nichia Optisolis™ and Nichia Vitasolis™

LIGHT INFO

LED Lifespan: L90 > 60.000 ore a 50° Celsius
Blue Light risk group (200 mm): EXEMPT UNLIMITED
Garanzia: 2 anni (disponibile estensione fino a 5 anni su richiesta)
Input LED: 24 V DC
Driver - Trasformatore: AC/DC 24 V

LED Lifespan: L90 > 60.000 hours at 50° Celsius
Blue Light risk group (200 mm): EXEMPT UNLIMITED
Warranty: 2 years (on request extension up to 5 years available)
Input LED: 24 V DC
Driver - Transformer: AC/DC 24 V

Temperatura colore

Color temperature

2700 K 4000 K

3000 K 5700 K

3500 K Tunable White

CCT 2000K, 2200K, 2500K, 5000K, 6500K, RGB, RGBW e
RGBTW su richiesta
On request CCT 2000K, 2200K, 2500K, 5000K, 6500K, RGB,
RGBW and RGBTW

Flusso luminoso output e potenza

Luminous flux output and power

W 100 mm

1000 x 2000 mm

P1 3741 lm

150 W

W 3.93 in

39.37 x 78.74 in

P2 6803 lm

280 W

W 150 mm

1500 x 2500 mm

P1 4624 lm

200 W

W 5.90 in

59.05 x 98.42 in

P2 9240 lm

370 W

W 200 mm

2000 x 3000 mm

P1 6255 lm

250 W

W 7.87 in

78.74 x 118.11 in

P2 11374 lm

480 W

Info LED

LED info

CRI $R_a = 100$ (Nichia Optisolis™) su richiesta

On request CRI $R_a = 100$ (Nichia Optisolis™)

CRI R_a min 90
 R_s min 50

LED Nichia

Dimmerabile Si
Dimmable Yes

(vedi pp. 214 - 215)
(see pp. 214 - 215)

illuminations

425 Peachtree Hills Ave. NE #3 Atlanta, GA 30305
404.876.1064 sales@illumco.com



.FRAME SUSPENDED

Codice prodotto
Product code

								[mm] [in]				
prodotto product	dimensioni sizes	flusso luminoso luminous flux	CCT	finiture alluminio aluminium finishings	finitura opale opal finishings	fissaggio fastening						
F.A .FRAME alimentazione remota remote power supply	10 W 100	P1 1 perimetro LED 1 LED perimeter	27 2700 K	W bianco white	G lucido gloss	S a sospensione suspended						
	20 1000 x 2000 W 3.93 39.37 x 78.74											
F.B .FRAME alimentazione integrata integrated power supply	15 W 150	P2 2 perimetri LED 2 LED perimeters	30 3000 K	B nero black	M opaco matte							
	25 1500 x 2500 W 5.90 59.05 x 98.42											
	20 W 200							35 3500 K	S speciale ¹ special ¹	OM opal milling ¹		
	30 2000 x 3000 W 7.87 78.74 x 118.11							40 4000 K		OS opal sculpture ¹		
								57 5700 K				
			TW Tunable White									
			RQ su richiesta on request									

¹Finiture speciali su richiesta (vedi pp. 156 - 159)
¹On request special finishings (see pp. 156 - 159)

Dimensioni disponibili
Available sizes

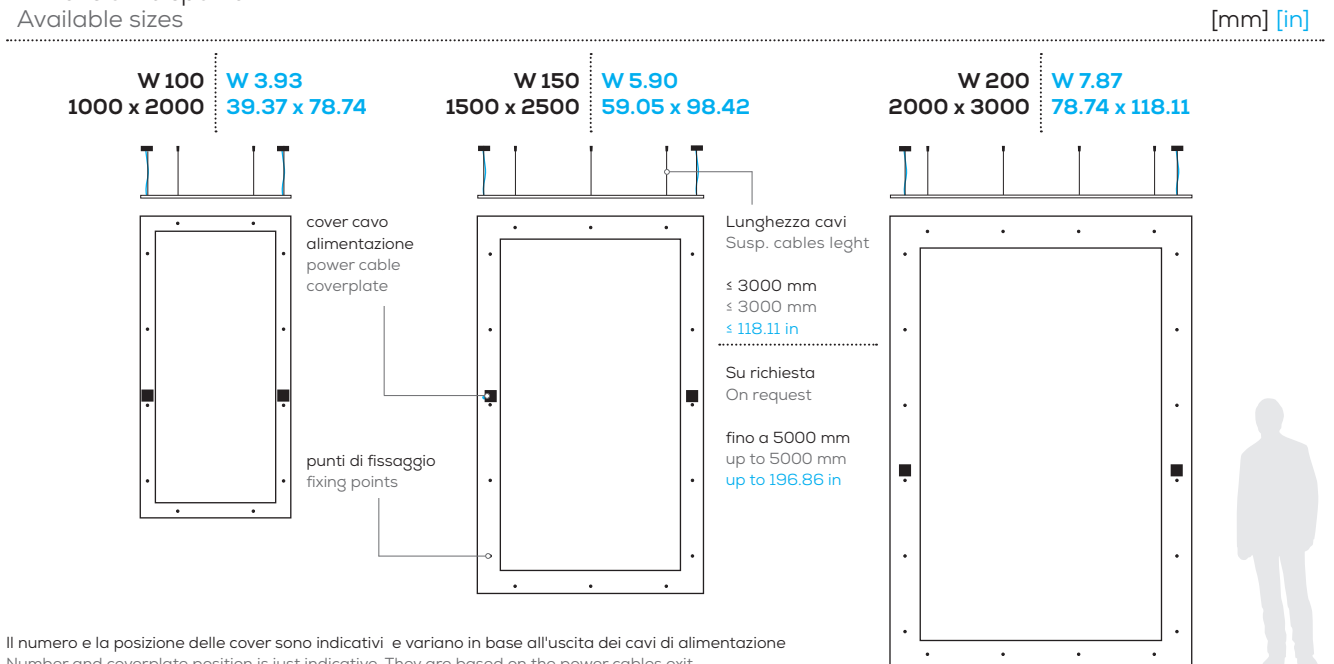

Il numero e la posizione delle cover sono indicativi e variano in base all'uscita dei cavi di alimentazione
Number and coverplate position is just indicative. They are based on the power cables exit

DETTAGLI E FINITURE DETAILS AND FINISHINGS

Finiture standard alluminio Standard aluminium finishings

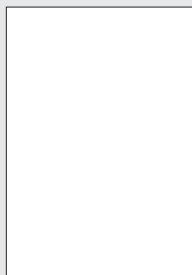

Bianco
White



Nero
Black

Finiture speciali alluminio - verniciatura (esempi) Special aluminium finishings - liquid painting (e.g.)

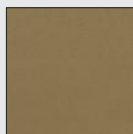

Bronzo
Bronze

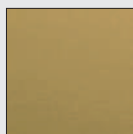

Ottone
Brass

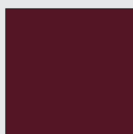

RAL 3005

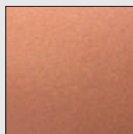

Rame
Copper



RAL 7035



RAL 7033

Finitura RAL personalizzata disponibile su richiesta
On request custom RAL finishing available

Finiture speciali alluminio - ossidazione (esempi) Special aluminium finishings - oxidation (e.g.)

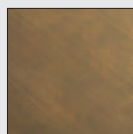

Bronzo
Bronze

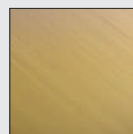

Ottone
Brass

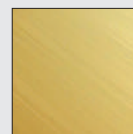

Oro
Gold

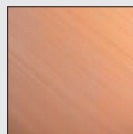

Rame
Copper

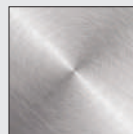

Cromato
Chrome

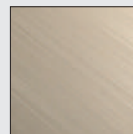

Champagne
Champagne

Dettagli sospensione Suspension details



①
Terminale Frame
Frame suspension
cable terminal



②
Rosone
Ceiling rose

Installazione cover Coverplate installation



③
Cover*
Coverplate*

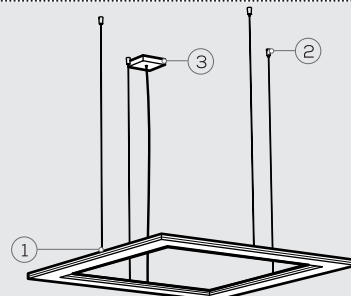

*Disponibile nelle finiture standard alluminio
*Available in standard aluminium finishings

FINITURE OPALE OPAL FINISHINGS

Finiture standard opale
Standard opal finishings

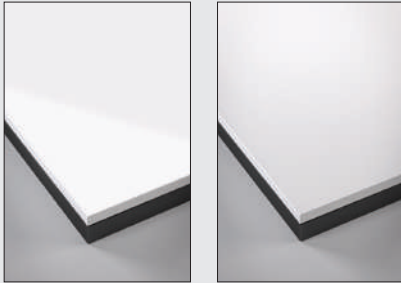

Lucido
Gloss

Opaco
Matte

OPAL MILLING

Finiture speciali opale - fresatura
Special opal finishings - milling

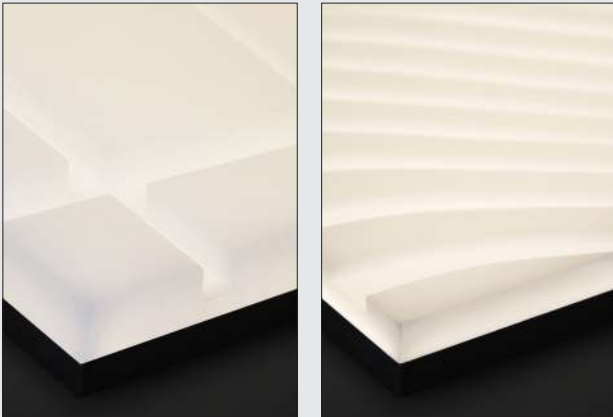

Su richiesta grafica personalizzabile
On request customizable graphic

La tridimensionalità, resa dalla fresatura del diffusore opale, crea dinamicità sulla superficie e permette alla luce di muoversi tra effetti di chiaro-scuro. L'alta qualità della sorgente luminosa è garantita dalla tecnologia FOLIO® che, unita alla fresatura, consente di lavorare con precisione anche le trame più complesse.

The three-dimensionality, made by milling the opal diffuser, creates dynamism on the surface, allowing brightness to move between light and shade effects. The high quality of the light source is guaranteed by the FOLIO® technology which, together with the milling, allows to create with precision even the most complex textures.

OPAL SCULPTURE

Finiture speciali opale - incisione laser
Special opal finishings - laser engraving



Su richiesta grafica personalizzabile
On request customizable graphic

L'incisione della superficie opale attraverso lavorazioni laser di ultima generazione, impreziosisce la sorgente luminosa creando delicati bassorilievi che le conferiscono carattere ed individualità. L'elevata precisione del processo di rimozione del materiale tramite incisione laser garantisce l'eccellente resa dei prodotti FOLIO®.

The opal surface engraving, through latest laser technologies, make the luminous fount more precious making delicate low reliefs that give character and individuality to the panels. The high precision of the material removal process by laser engraving guarantees the excellent yield of the FOLIO® products.

.FOLIO® SPOT.MATE®

INTEGRABLE ON REQUEST WITHIN THE FOLLOWING FOLIO® COLLECTION

.LINE

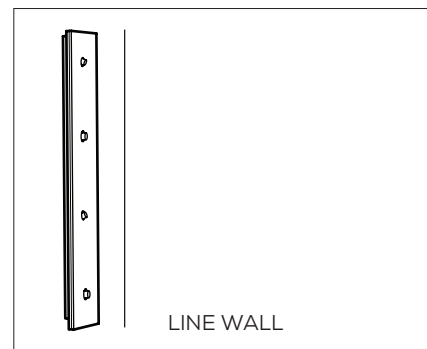
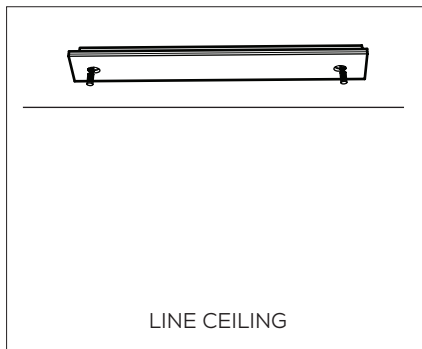
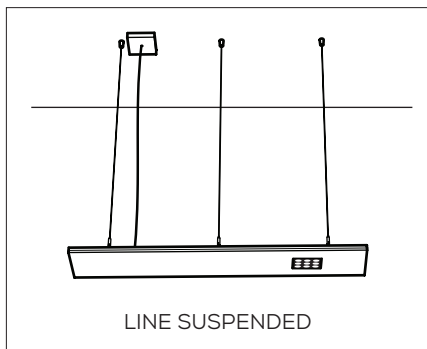

LED

Sizes



DOMINO QUAD

NICHIA

88 x 88 mm

3.46 x 3.14 in



DOMINO LINEAR

NICHIA

172 x 32 mm

6.77 x 1.25 in



PICO 26.t

NICHIA

Ø 26 mm

Ø 1.02 in



PICO 26.a

NICHIA

Ø 26 mm

Ø 1.02 in



MICRO 40.t

NICHIA

Ø 40 mm

Ø 1.57 in



MICRO 40.t

OLE SORAA

Ø 40 mm

Ø 1.57 in



MICRO 40.a

NICHIA

Ø 40 mm

Ø 1.57 in



MICRO 40.a

OLE SORAA

Ø 40 mm

Ø 1.57 in



MINI 62.a

NICHIA

Ø 62 mm

Ø 2.44 in



MINI 62.a

OLE SORAA

Ø 62 mm

Ø 2.44 in



MIDI 77.a

NICHIA

Ø 77 mm

Ø 3.03 in



MIDI 77.a

ARCANE MODULE

Ø 77 mm

Ø 3.03 in

Contact FOLIO® for your net price multiplier.

All prices include fixing system, standard CCT options & standard finishes.

Power supplies for Spot.Mate® are not included. Shipping is not included. 22