

FLOS

String Lights, Round (12 m) - Specification Sheet by Michael Anastassiades, 2014

Mounting	Ceiling Pendant
Lamp (Bulb) Description	1 LED ARRAY 2700K 1910 lm CRI90 - 26W
Environment	Indoor - Dry Location
Finish	Black
Technical and Product Description	STRING LIGHTS suspension lamp providing diffused light. Matt black varnished die-cast aluminum body coated with clear soft-touch varnish. Optical diffuser in opal PC. Suspension system of 12 or 22 meters with Kevlar reinforced coaxial cable (the fixture should be relaxed and then re-tightened 24-hours after installation).

NOTE: Please connect the String Lights to an on/off switch. Dimming capability is only possible for electronics with optical mechanism and can be operated either with our [app](#) or by using the sensor on the luminaire.

This item requires the separate purchase of either a wall/ceiling connection CANOPY or BASE power supply with floor switch. Please select the appropriate Model/Color combination when making your purchase.

Please inquire for further details with customer service for installation guidance and refer to the [Installation Guide](#). You can also watch the installation video [here](#).

Electrical

Voltage	120
IP Rating	IP20

Physical

Cord Length (inches)	472" - Black
Construction Material	Aluminum, Polycarbonate
Weight	2.5 lbs



● F6480030 Black

Dimensional Image

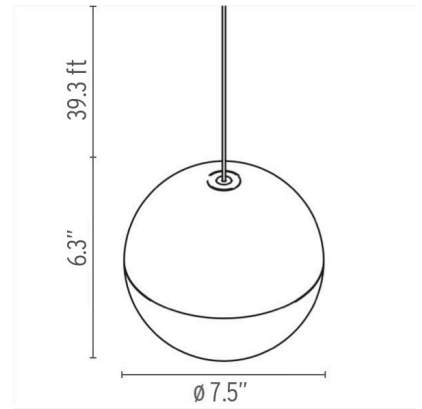

Certifications

