

Aeris 30 / Aeris 54
 linear pendant

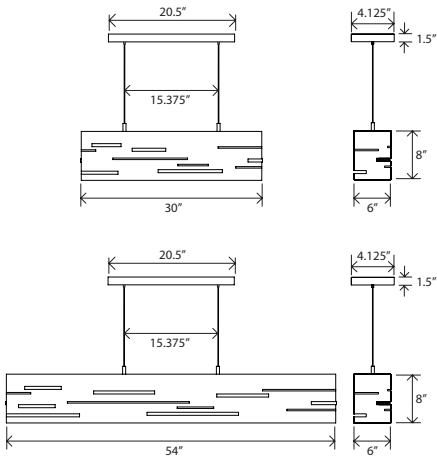





Aeris 30 dimensions - 30" x 6" x 8" H
 Aeris 54 dimensions - 54" x 6" x 8" H
 Solid wood, aluminum
 Aeris 30 weight - 11 lbs, Aeris 54 weight - 15 lbs
 Energy efficient LED light source
 Light output - 1720 lumens
 [Down light - 1030, Up light - 690]
 Light color - 2700 K (warm)
 Color accuracy - 90+ CRI
 LED power consumption - 16W
 Input voltage - 120V
 Dimmable (use ELV or TRIAC dimmer)
 Linear canopy included
 Wood canopy covers are now available
 Walnut canopy cover: part #60-130-005W
 Dark Stained Walnut canopy cover: part #60-130-005D
 See page 36 for more canopy information
 6' drop length, field adjustable
 Suitable for a sloped ceiling
 Wood grain will vary
 Specifications subject to change



MATERIAL & FINISH OPTIONS

Aeris 30 part # 07-110 - 
 Aeris 54 part # 07-100 - 

Metal Finish:
 brushed aluminum (CM-006) A 
 black anodized aluminum (CM-007) B 

Wood Body:
 walnut (CM-001) W 
 dark stained walnut (CM-002) D 

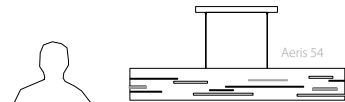

Alternate input voltages available



The Aeris was a collaboration with New York based designer Frank Carfaro of Desiron. The organic and often wild swirls of walnut grain are interrupted by rigorous slits and inlays that punctuate each face to create a beautiful juxtaposition, making each fixture unique. The glow of the illuminated wood seen through the cut slits creates a rich composition of light and shadow.

*Nick Sheridan
 Co-Designer*

Non-pictured finish options

 Dark Stained Walnut (CM-002)  Black Anodized Aluminum (CM-007)

©2016 Cerno, L.L.C. All Rights Reserved. The Cerno graphic is a registered trademark of cerno, L.L.C. Cerno reserves the right to change specifications for product improvements without notification.



walnut Aeris 54

02 ARCHITECTURE

425 Peachtree Hills Ave. NE #3 Atlanta, GA 30305
 404.876.1064
 sales@illumco.com