



## Product Specification Sheet

### BuzziPleat Light 100-240V/277V

— By 13&9 Design

#### **Sculptural pendant enfolds silence and light**

BuzziPleat, a dynamic series of acoustic solutions by 13&9, delivers sound control with architectural edge. Traditional fashion design techniques, like smocking and pleating, are reinterpreted with sound-absorbing BuzziFelt to create large architectural folds, which maximize surface to deliver exceptional acoustic performance. The suspended BuzziPleat Light configuration marries sound control and illumination. It is equipped with BuzziSol, a powerful LED light source. The dimmable warm light gives BuzziPleat an even greater sense of depth.

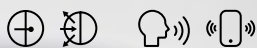

# The Family

## Models

**BuzziPleat Light Edel**

**BuzziPleat Light Edel Long**

**BuzziPleat Light Ripple**

**Sol Solo Globe**

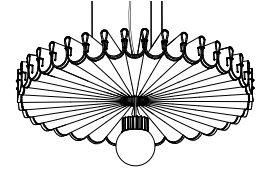
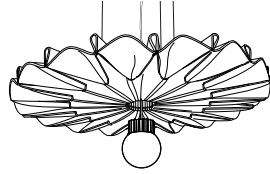

**Sol Solo Spot**

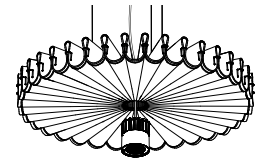
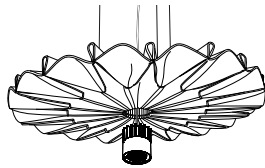

**Sol Trio Globe**

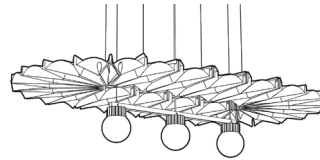

**Sol Trio Spot**

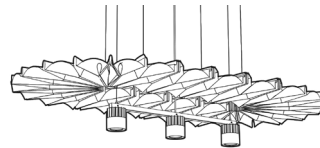

**Sol Quintet Globe**

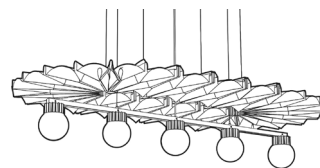

**Sol Quintet Spot**

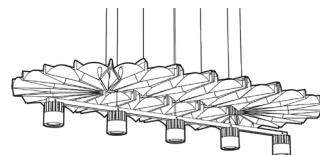

Lighting Units

Required order information

1. Model
2. Size
3. BuzziFelt Color
4. Option Extra Layer BuzziFabric
5. Light Option
6. Mounting System
7. Color Lace

# Lighting Data

---

## Lighting Units

### BuzziSol Globe



BuzziSol collection are suspended LED fixtures consisting of 1, 3 or 5 powder-coated black heatsinks with LED chip on board (COB) light sources.

The product can be finished with a frosted glass globe diffuser which spreads the light in a large beam angle of 170°, enlighting the surroundings or reflector spot adaptors directing the light with a beam angle of 38° downwards.

### Spot



# Lighting specifications

## BuzziPleat Light Edel Medium | Small

| Lighting Unit  | Voltage       | Wattage | Light Output Luminaire | Efficacy (Lm/W) | CRI | Dimming | Color Temperature | UGR | Standard (stock) On request (>LT) | Color Power Cable | Color Ceiling Canopy | Color Lace        | Fabric Collection     | Fabric Color          | Mounting Option   |
|----------------|---------------|---------|------------------------|-----------------|-----|---------|-------------------|-----|-----------------------------------|-------------------|----------------------|-------------------|-----------------------|-----------------------|---|
| Sol Solo Globe | 110-240V/277V | 32W     | 1500 Lm                | 46,8            | 90  | 1-10V   | 3000K             | 23  | Standard                          | Black             | Black                | OffWhite or Black | Use color codes below | Use color codes below | 3 cables of 78.74" Alu or Black<br>3 cables of 196.85" Alu or Black |
| Sol Solo Spot  | 110-240V/277V | 32W     | 1500 Lm                | 46,8            | 90  | 1-10V   | 3000K             | 12  | Standard                          | Black             | Black                | Black             | Use color codes below | Use color codes below | 3 cables of 78.74" Alu or Black<br>3 cables of 196.85" Alu or Black |

## BuzziPleat Light Ripple Medium | Small

| Lighting Unit  | Voltage       | Wattage | Light Output Luminaire | Efficacy (Lm/W) | CRI | Dimming | Color Temperature | UGR | Standard (stock) On request (>LT) | Color Power Cable | Color Ceiling Canopy | Color Lace        | Fabric Collection     | Fabric Color          | Mounting Option   |
|----------------|---------------|---------|------------------------|-----------------|-----|---------|-------------------|-----|-----------------------------------|-------------------|----------------------|-------------------|-----------------------|-----------------------|---|
| Sol Solo Globe | 110-240V/277V | 32W     | 1500 Lm                | 46,8            | 90  | 1-10V   | 3000K             | 23  | Standard                          | Black             | Black                | OffWhite or Black | Use color codes below | Use color codes below | 3 cables of 78.74" Alu or Black<br>3 cables of 196.85" Alu or Black |
| Sol Solo Spot  | 110-240V/277V | 32W     | 1500 Lm                | 46,8            | 90  | 1-10V   | 3000K             | 12  | Standard                          | Black             | Black                | Black             | Use color codes below | Use color codes below | 3 cables of 78.74" Alu or Black<br>3 cables of 196.85" Alu or Black |

## BuzziPleat Light Edel Long Medium

| Lighting Unit     | Voltage       | Wattage | Light Output Luminaire | Efficacy (Lm/W) | CRI | Dimming | Color Temperature | UGR | Standard (stock) On request (>LT) | Color Power Cable | Color Ceiling Canopy | Color Lace        | Fabric Collection     | Fabric Color          | Mounting Option   |
|-------------------|---------------|---------|------------------------|-----------------|-----|---------|-------------------|-----|-----------------------------------|-------------------|----------------------|-------------------|-----------------------|-----------------------|---|
| Sol Trio Globe    | 110-240V/277V | 60W     | 3 x 1500 Lm            | 75              | 90  | 1-10V   | 3000K             | 23  | 12                                | Black             | Black                | OffWhite or Black | Use color codes below | Use color codes below | 4 cables of 78.74" Alu or Black<br>4 cables of 196.85" Alu or Black |
| Sol Trio Spot     | 110-240V/277V | 60W     | 3 x 1500 Lm            | 75              | 90  | 1-10V   | 3000K             | 12  | 12                                | Black             | Black                | Black             | Use color codes below | Use color codes below | 4 cables of 78.74" Alu or Black<br>4 cables of 196.85" Alu or Black |
| Sol Quintet Globe | 110-240V/277V | 90W     | 5 x 1500 Lm            | 83              | 90  | 1-10V   | 3000K             | 23  | 12                                | Black             | Black                | Black             | Use color codes below | Use color codes below | 4 cables of 78.74" Alu or Black<br>4 cables of 196.85" Alu or Black |
| Sol Quintet Spot  | 110-240V/277V | 90W     | 5 x 1500 Lm            | 83              | 90  | 1-10V   | 3000K             | 12  | 12                                | Black             | Black                | Black             | Use color codes below | Use color codes below | 4 cables of 78.74" Alu or Black<br>4 cables of 196.85" Alu or Black |



# Photometric Data

## BuzziPleat Light BuzziSol Solo

Sol Solo Globe Cartesian diagram

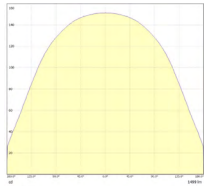

Sol Solo Globe Polar curve

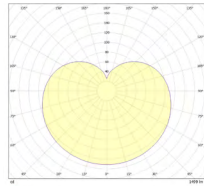

Sol Solo Spot Cartesian diagram

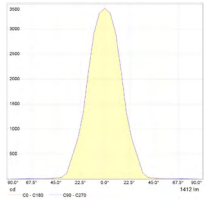

Sol Solo Spot Polar curve

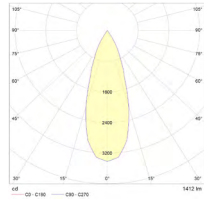

## BuzziPleat Light BuzziSol Trio

Sol Trio Globe Cartesian diagram

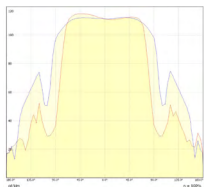

Sol Trio Globe Polar curve

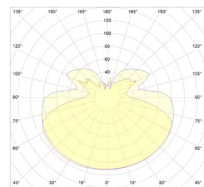

Sol Trio Spot Cartesian diagram

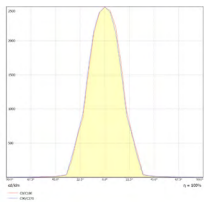

Sol Trio Spot Polar curve

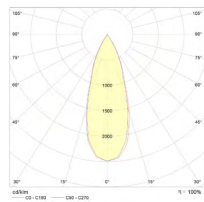

## BuzziPleat Light BuzziSol Quintet

Sol Quintet Globe Cartesian diagram

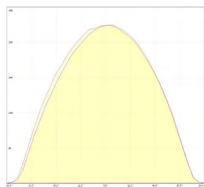

Sol Quintet Globe Polar curve

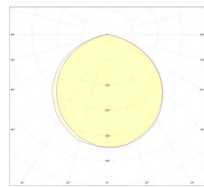

Sol Quintet Spot Cartesian diagram

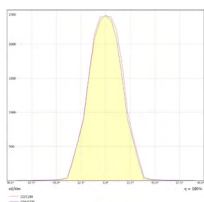

Sol Quintet Spot Polar curve

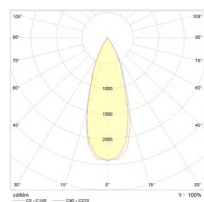

---

## Tips and Tricks - Light Options

To enlighten your workplace with optimal lux levels take following measurements into account:

### BuzziPleat Light BuzziSol Solo

#### Solo Spot

Office,  
Meeting room

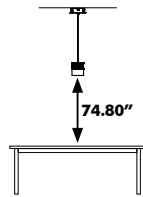

500 Lux

#### Solo Globe

Office,  
Meeting room

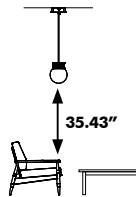

100 Lux

### BuzziPleat Light BuzziSol Trio

#### Trio Spot

Office,  
Meeting room

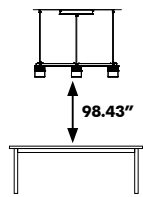

500 Lux

#### Trio Globe

Office,  
Meeting room

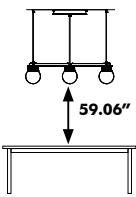

500 Lux

### BuzziPleat Light BuzziSol Quintet

#### Quintet Spot

Office  
Meeting room

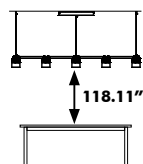

500 Lux

#### Quintet Globe

Office,  
Meeting room

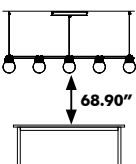

500 Lux

\* According to EN12464

# Product Data

## Fixing System

### Fixing System Acoustic Panel

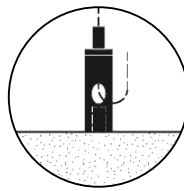
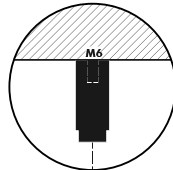
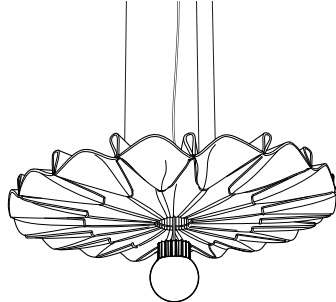

BuzziPleat Light Edel and Ripple are suspended on 3 cables of 78.74" or 196.85" black or alu colored cables, with fixing system screw.

BuzziPleat Light Edel Long is suspended on 4 cables of 78.74" or 196.85" black or alu colored cables, with fixing system screw.

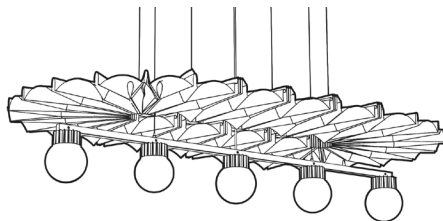

### Fixing System Lighting

The light element of BuzziPleat Light Edel Long is suspended independently from the acoustic panel with 2 cables of 78.74" or 196.85" black or alu colored cables, with fixing system screw.

⚠ If installing on suspended ceiling, verify load capacity prior to installation. Ensure a min distance of 3.94" between the felt shade and the LED luminaire.

## Acoustic Panel



The acoustic panel consists of one layer of BuzziFelt, with an OffWhite or Black lace. The lightweight sculptural shade is created by pleating or smocking sound absorbing BuzziFelt. The architectural folds maximize surface area, delivering exceptional acoustic performance.



Absorption



Diffusion



Mid tone



High tone

Optional: an extra layer of BuzziFabric can be added on 1 side (only in combination with OffWhite or Anthracite Felt).

# Acoustics Data

## BuzziPleat Ceiling Suspended

### Equivalent sound absorption area in m<sup>2</sup> per object

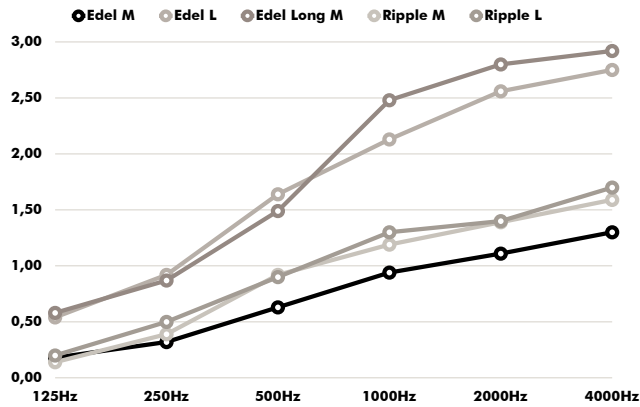

| Hz   | Edel M<br>Aeq/m <sup>2</sup> | Edel L<br>Aeq/m <sup>2</sup> | Edel Long M<br>Aeq/m <sup>2</sup> | Ripple M<br>Aeq/m <sup>2</sup> | Ripple L<br>Aeq/m <sup>2</sup> |
|------|------------------------------|------------------------------|-----------------------------------|--------------------------------|--------------------------------|
| 125  | 0.18                         | 0.54                         | 0.58                              | 0.14                           | 0.20                           |
| 250  | 0.32                         | 0.92                         | 0.87                              | 0.39                           | 0.50                           |
| 500  | 0.63                         | 1.64                         | 1.49                              | 0.92                           | 0.90                           |
| 1000 | 0.94                         | 2.13                         | 2.48                              | 1.19                           | 1.30                           |
| 2000 | 1.11                         | 2.56                         | 2.80                              | 1.39                           | 1.40                           |
| 4000 | 1.30                         | 2.75                         | 2.92                              | 1.59                           | 1.70                           |



# Dimensions

## BuzziPleat Light Ripple

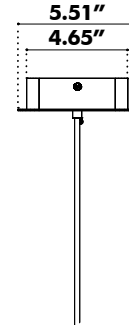
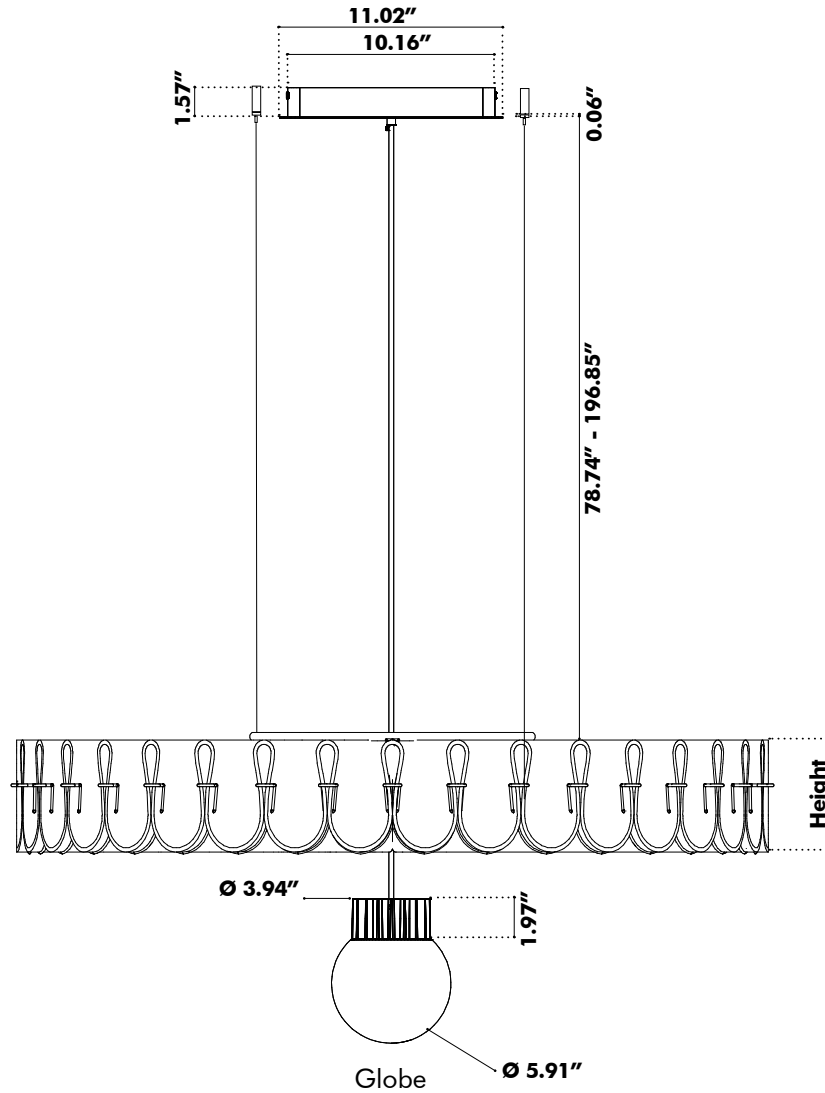

| Height | M | 13 cm   |
|--------|---|---------|
|        | L | 19,5 cm |

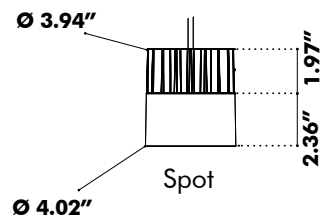

| Width | M | Ø 100 cm |
|-------|---|----------|
|       | L | Ø 150 cm |

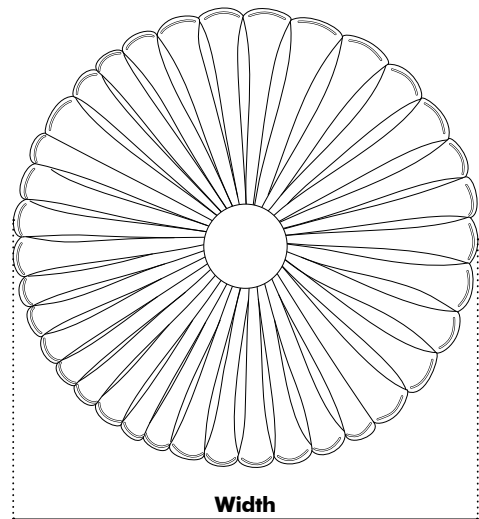

# BuzziPleat Light Edel

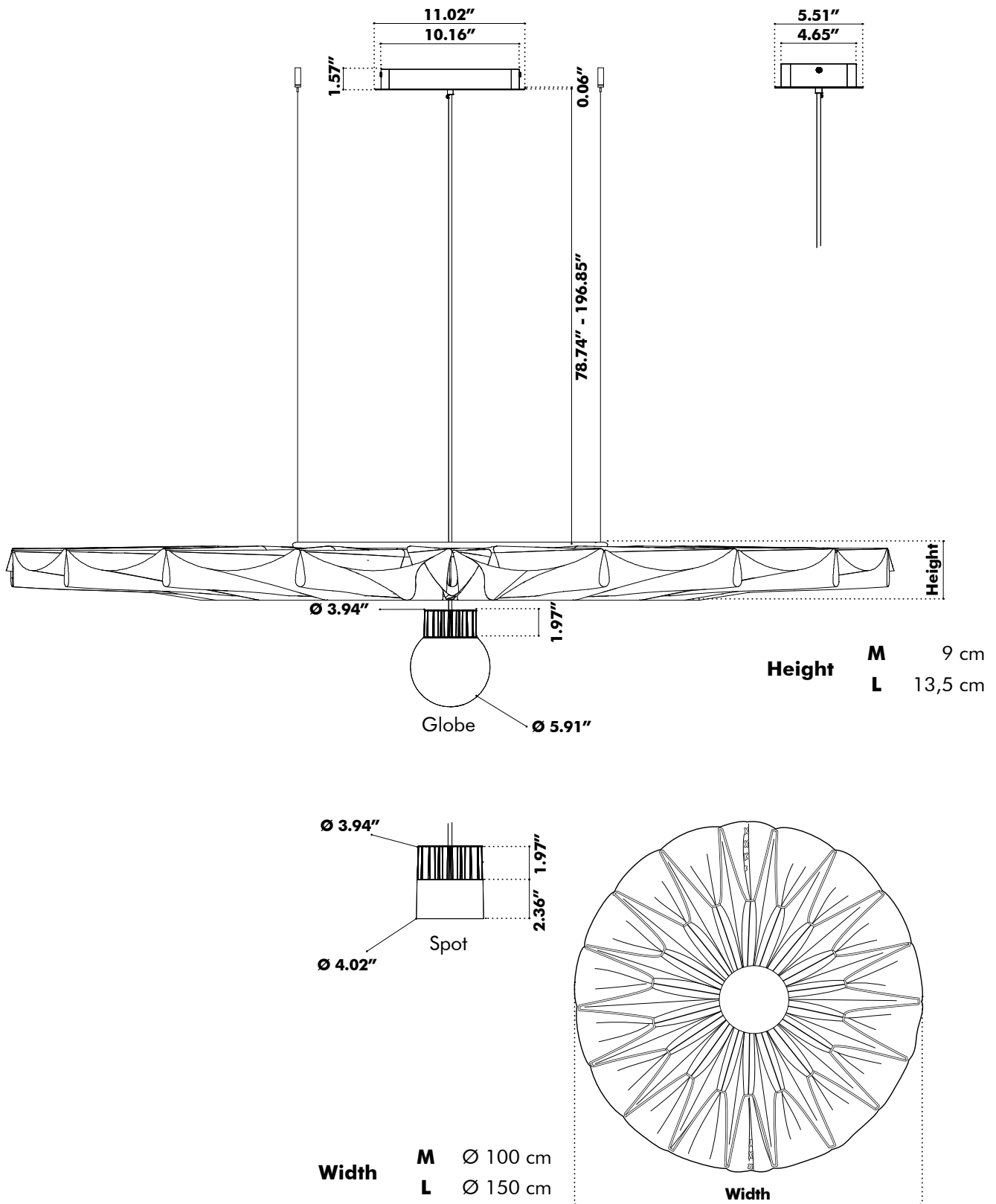

# BuzziPleat Light Edel Long Trio

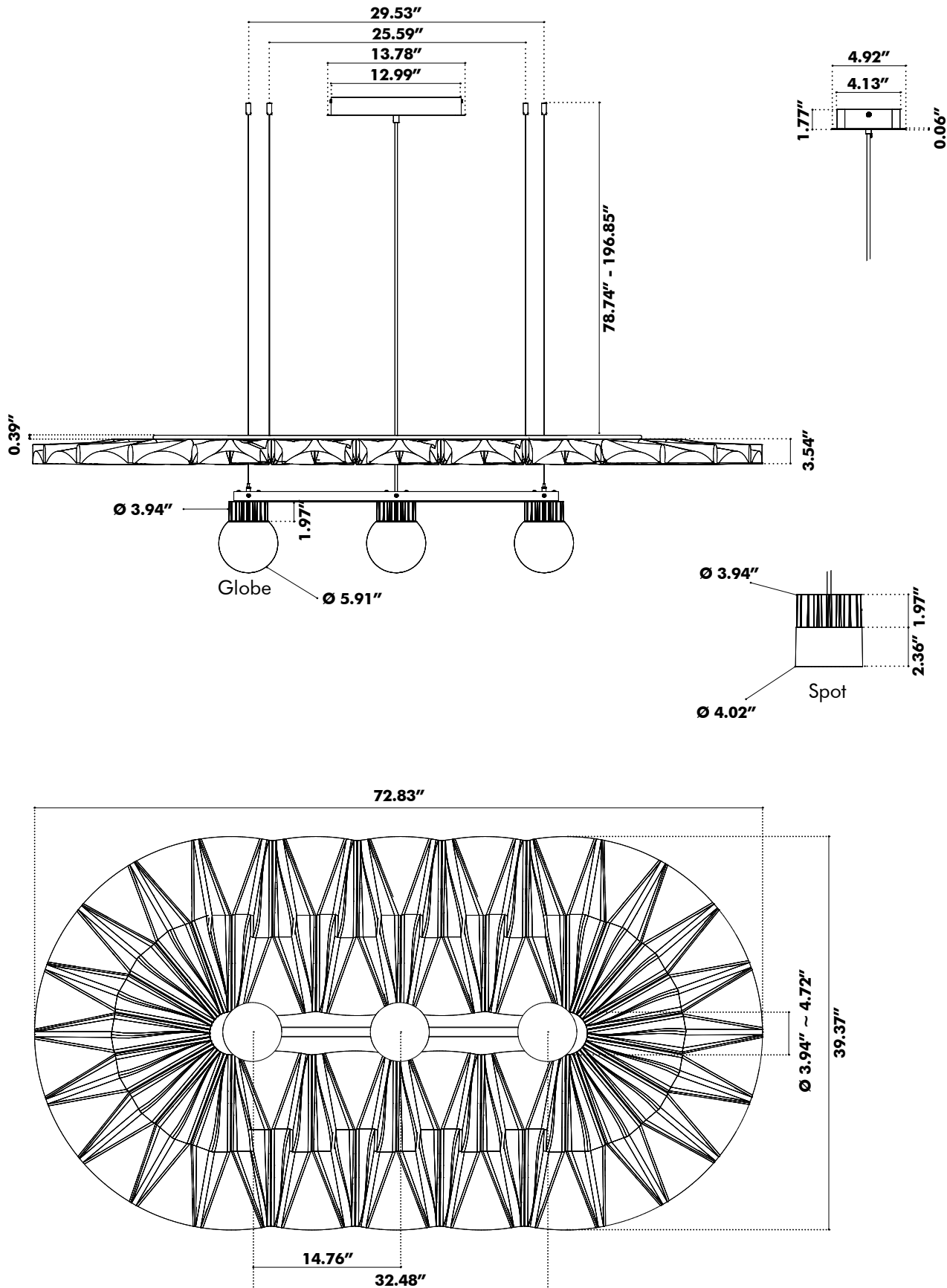

# BuzziPleat Light Edel Long Quintet

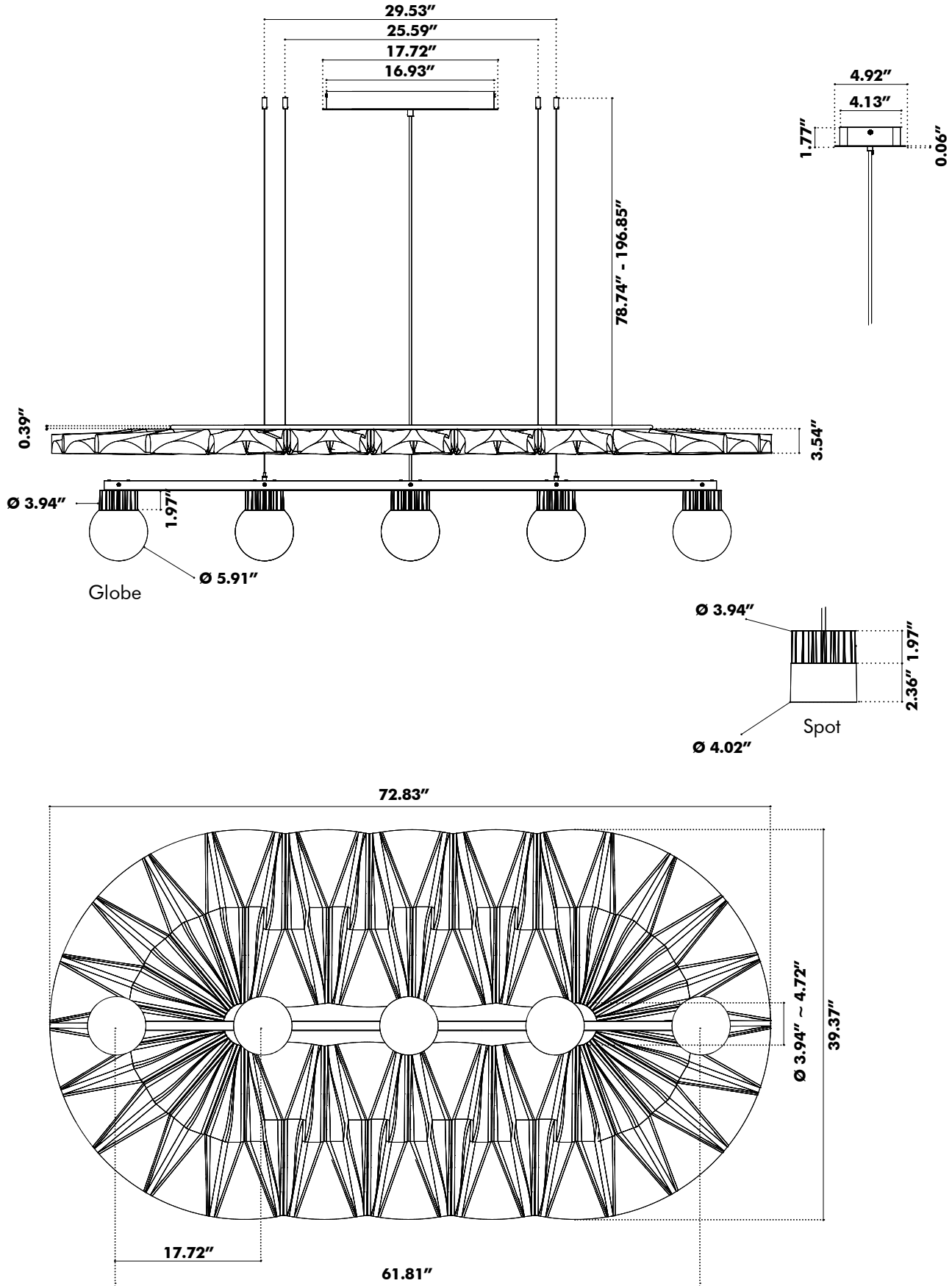

---

## Weights

### BuzziPleat Light Ripple Medium | Large BuzziSol Solo

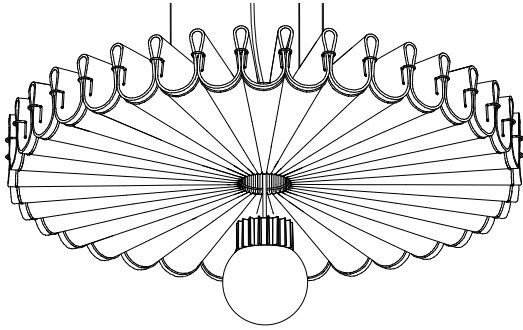

⚖ Medium: 14.77 lbs  
Large: 27.34 lbs

### BuzziPleat Light Edel Medium | Large BuzziSol Solo

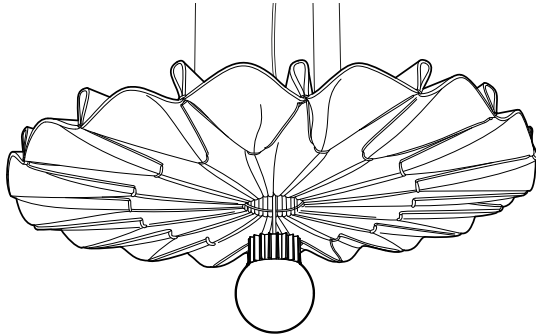

⚖ Medium: 12.57 lbs  
Large: 22.93 lbs

### BuzziPleat Light Edel Long Trio BuzziSol Trio

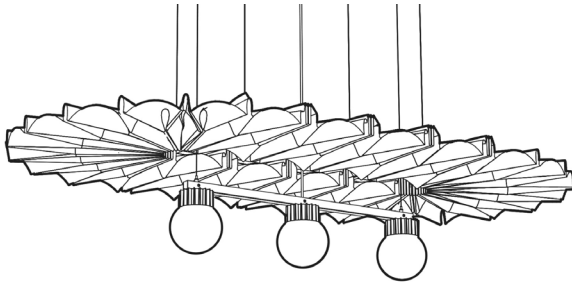

⚖ 30.86 lbs

### BuzziPleat Light Edel Long Quintet BuzziSol Quintet

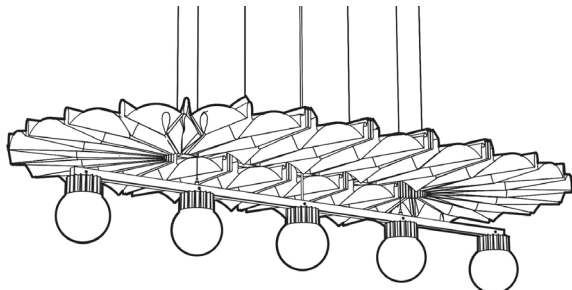

⚖ 36.38 lbs

# Fabrics

---

## Felt

**Composition** 100% Recycled P.E.T. Felt, latex backing

**Weight** 1.000 g/m<sup>2</sup> | 29.49 oz/yd<sup>2</sup>

**Abrasion resistance** >7.000 Martindale

**Flammability** EU: EN 13501.1 + A1/2009 Class B-s1,d0  
USA: ASTM E84 Class A certified

**Fastness to light** USA 5



FE-OffWhite 63\*

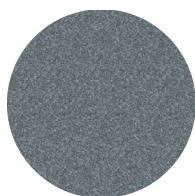

FE-StoneGrey 67

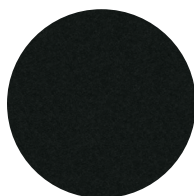

FE-Anthracite 68\*

\*Extra layer BuzziFabric Possible

---

## Fabric (45 colors)

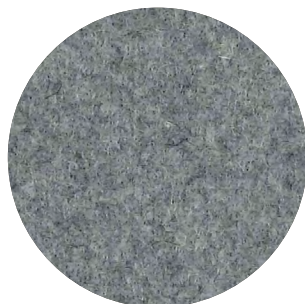

**Category A**

**Composition** 70% Recycled Wool, 25% Recycled Polyacryl,  
5% Recycled Other Fabrics

**Weight** 405 g/m<sup>2</sup> | 11.94 oz/yd<sup>2</sup>

**Abrasion resistance** 40.000 Martindale, 50,000 Wyzenbeek

**Flammability** EU: EN 1021.1/2006 | BS EN 1021.1/2006 (cigarette).  
EN 1021.2/2006 | BS EN 1021.2/2006 (match)

USA: CAL TB 117 | ASTM E84 CLASS A

**Fastness to light** EU: 4 | USA 4

**Fastness to rubbing** EU: Wet 3-4 | Dry 4-5

**Fastness to crocking** USA: Wet 5 | Dry 5

