



Product Specification Sheet

BuzziChip 100-240V/277V

— By BuzziSpace Studio

A playful acoustic powerhouse

BuzziChip's curved design helps you move away from hard edges while adding a playful touch to any area. Depending on the size, BuzziChip Light can be fitted with our integrated LED solutions: BuzziSol Solo, BuzziSol Trio and BuzziSol Quintet in either a Globe or Spot iteration. Combine the different models in various fabrics and colors to form a playful and dynamic ceiling in your office or residential space.



The Family

Models

BuzziChip Small

BuzziChip Medium

BuzziChip Large

Sol Solo Globe

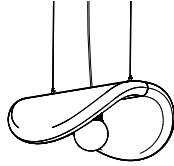

Sol Solo Spot

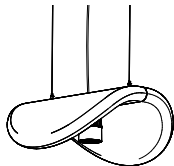

Sol Trio Globe

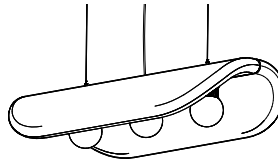

Sol Trio Spot

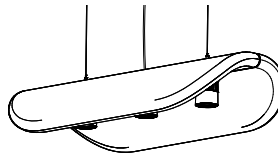

Sol Quintet Globe

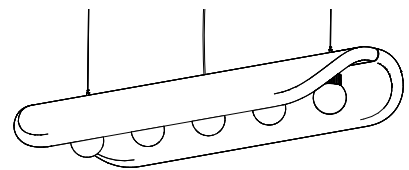

Sol Quintet Spot

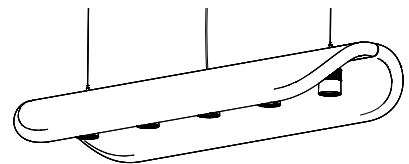

Lighting Units

Required order information

1. Size
2. Light Option
3. Fabric (CAT -> Collection -> Color)
4. Mounting Option

Lighting Data

Lighting Units

BuzziSol Globe



BuzziSol collection are suspended LED fixtures consisting of 1, 3 or 5 powder-coated black heatsinks with LED chip on board (COB) light sources.

The product can be finished with a frosted glass globe diffuser which spreads the light in a large beam angle of 170°, enlighting the surroundings or reflector spot adaptors directing the light with a beam angle of 38° downwards.

Spot



Lighting specifications

BuzziChip Small

Lighting Unit	Voltage	Wattage	Light Output Luminaire	Efficacy (Lm/W)	CRI	Dimming	Color Temperature	UGR	Standard (stock) On request (>LT)	Color Power Cable	Color Ceiling Canopy	Fabric Collection	Fabric Color	Mounting Option
Sol Solo Globe	110 - 240V/277V	32W	1500 Lm	46,8	90	1-10V	3000K	23	Standard	Black	Black	Use color codes below	Use color codes below	2 cables of 78,74" Alu or Black 2 cables of 196,85" Alu or Black
Sol Solo Spot	110 - 240V/277V	32W	1500 Lm	46,8	90	1-10V	3000K	12	Standard	Black	Black	Use color codes below	Use color codes below	2 cables of 78,74" Alu or Black 2 cables of 196,85" Alu or Black

BuzziChip Medium

Lighting Unit	Voltage	Wattage	Light Output Luminaire	Efficacy (Lm/W)	CRI	Dimming	Color Temperature	UGR	Standard (stock) On request (>LT)	Color Power Cable	Color Ceiling Canopy	Fabric Collection	Fabric Color	Mounting Option
Sol Trio Globe	110 - 240V/277V	60W	3 x 1500 Lm	75	90	1-10V	3000K	23	Standard	Black	Black	Use color codes below	Use color codes below	2 cables of 78,74" Alu or Black 2 cables of 196,85" Alu or Black
Sol Trio Spot	110 - 240V/277V	60W	3 x 1500 Lm	75	90	1-10V	3000K	12	Standard	Black	Black	Use color codes below	Use color codes below	2 cables of 78,74" Alu or Black 2 cables of 196,85" Alu or Black

BuzziChip Large

Lighting Unit	Voltage	Wattage	Light Output Luminaire	Efficacy (Lm/W)	CRI	Dimming	Color Temperature	UGR	Standard (stock) On request (>LT)	Color Power Cable	Color Ceiling Canopy	Fabric Collection	Fabric Color	Mounting Option
Sol Quintet Globe	110 - 240V/277V	90W	5 x 1500 Lm	83	90	1-10V	3000K	23	Standard	Black	Black	Use color codes below	Use color codes below	2 cables of 78,74" Alu or Black 2 cables of 196,85" Alu or Black
Sol Quintet Spot	110 - 240V/277V	90W	5 x 1500 Lm	83	90	1-10V	3000K	12	Standard	Black	Black	Use color codes below	Use color codes below	2 cables of 78,74" Alu or Black 2 cables of 196,85" Alu or Black



cULus listed

Product Data

Fixing System

Fixing System Acoustic Panel

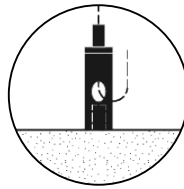
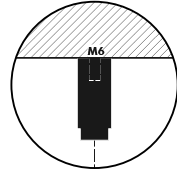
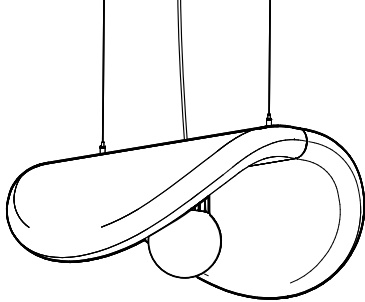

BuzziChip Small is suspended on 2 cables of 78.74" or 196.85" black or alu colored cables, with fixing system screw.

Fixing System Lighting

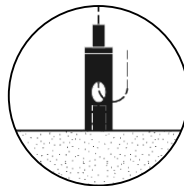
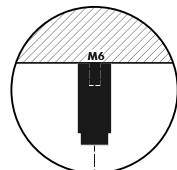
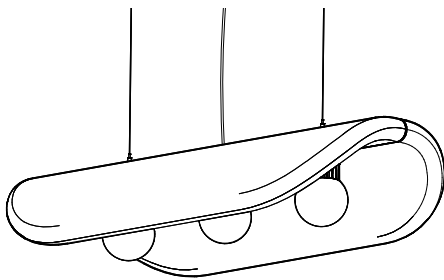

The light elements of BuzziChip Medium and BuzziChip Large are suspended independently from the acoustic panel with 2 cables of 78.74" - 196.85" black or alu colored cables, with fixing system screw.

⚠ If installing on suspended ceiling, verify load capacity prior to installation.

Acoustic Panel



The acoustic panel is upholstered front to back in a chosen fabric.



Absorption



Low tone



Mid tone



High tone

BuzziChip Large

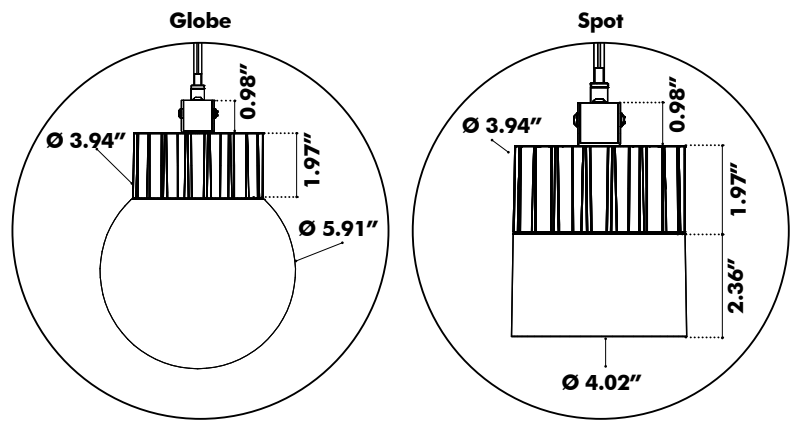
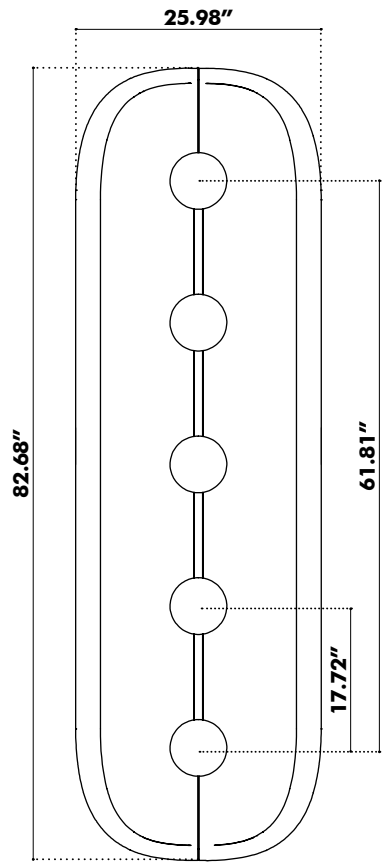
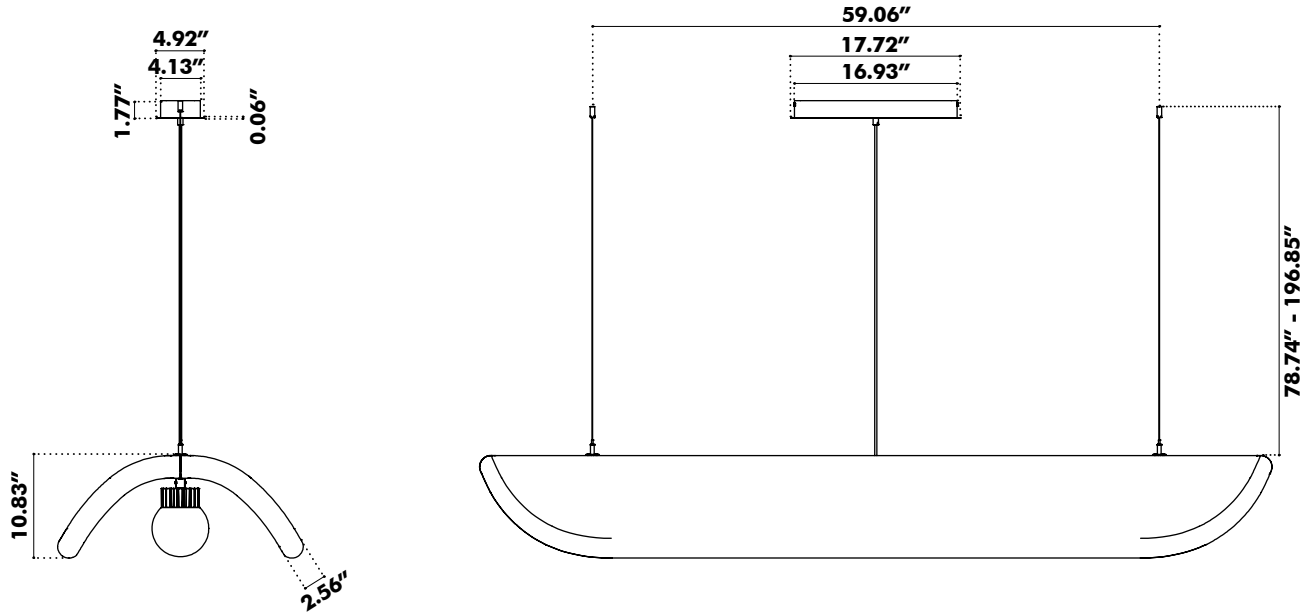

Fabrics

Fabric (45 colors)

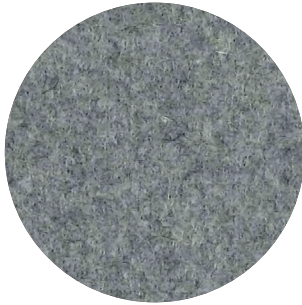

Category A

Composition 70% Recycled Wool, 25% Recycled Polyacryl,
5% Recycled Other Fabrics

Weight 405 g/m² | 11.94 oz/yd²

Abrasion resistance 40.000 Martindale, 50,000 Wyzenbeek

Flammability EU: EN 1021.1/2006 | BS EN 1021.1/2006 (cigarette).
EN 1021.2/2006 | BS EN 1021.2/2006 (match)
USA: CAL TB 117 | ASTM E84 CLASS A

Fastness to light EU: 4 | USA 4

Fastness to rubbing EU: Wet 3-4 | Dry 4-5

Fastness to crocking USA: Wet 5 | Dry 5



Trevira CS+ | CS (47 colors)

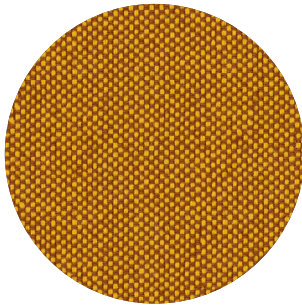

Category A

Weight 420 g/m² | 12.39 oz/yd²

Composition 100% Polyester, Trevira CS

Abrasion resistance 100.000 Martindale, 90,000 Wyzenbeek

Flammability BS 5852 part II: CRIB 5 | BS 7176 Medium Hazard
USA: CAL TB 117 | M1 | B1 | EN 1021/1-2 | C1 |
IMO Res. A652 (16)

Fastness to light EU: 6 | USA 5

Fastness to rubbing EU: Wet 4-5 | Dry 4-5

Fastness to crocking USA: Wet 5 | Dry 5



Clara 2 (24 colors)

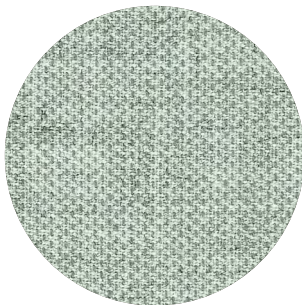

Category B

Composition 92% new wool, 8% nylon

Weight 400 g/lin.m

Abrasion resistance 80.000 Martindale rubs, EN ISO 12947

Flammability EN 1021-1/2 | BS 5852, ignition source 2-3 | DIN 4102 B2
NF D 60 013 | UNI 9175 1IM | US Cal. Tech. Bull. 117, Sec. E
NFPA 260 | IMO A.652(16)

Fastness to light Note 5-7, ISO 105-B02

Fastness to rubbing (ISO) dry 4-5, wet 4

Pilling Note 4, EN ISO 12945



kvadrat

Hero 2 (33 colors)

kvadrat

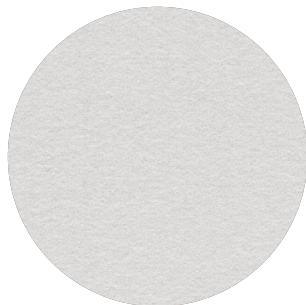

Category C

Composition 97% new wool, 3% nylon

Weight 580 g/lin.m

Abrasion resistance 45.000 Martindale rubs, EN ISO 12947

Flammability EN 1021-1/2 | DIN 4102 B2 | NF D 60 013
UNI 9175 1IM | US Cal. Bull. 117-2013 | NFPA 260
IMO A.652 (16)

Fastness to light Note 5-6, ISO 105-B02

Fastness to rubbing (ISO) dry 4-5, wet 4-5

Pilling Note 3-4, EN ISO 12945



Tonus 4 (47 colors)

kvadrat



Category D

Composition 90% new wool, 10% Helanca

Weight 665 g/lin.m

Abrasion resistance 100.000 Martindale rubs, EN ISO 12947

Flammability EN 1021-1/2 | BS 5852 part 1 | DIN 4102 B2
Önorm B1/Q1 | NF D 60 013 | UNI 9175 1IM
US Cal. Bull. 117-2013 | NFPA 260 | IMO A.652 (16)

Fastness to light Note 5-7, ISO 105-B02

Fastness to rubbing (ISO) dry 3-5, wet 3-5

Pilling Note 3, EN ISO 12945



Memory 2 (20 colors)

kvadrat

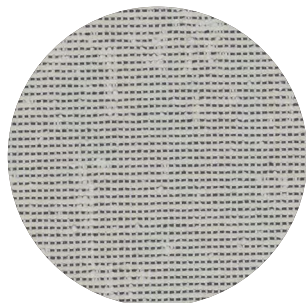

Category E

Composition 100% Trevira CS

Weight 700 g/lin.m

Abrasion resistance

35.000 rubs acc. to the Martindale method, EN ISO 12947

Flammability EN 1021-1/2 | DIN 4102 B1 | Önorm B1/Q1
NF D 60 013 | NF P 92 507 M1 | UNI 9175 1IM
UNI 9177 classe 1 | US Cal. Tech. Bull. 117
IMO A.652 (16)

Fastness to light Note 5-8, ISO 105-B02

Fastness to rubbing (ISO) dry 4-5, wet 4-5

Pilling Note 4, EN ISO 12945

