

# BUSTER + PUNCH

LONDON

## HOOKED WALL / SMALL

TECH SPEC



HOOKED WALL / SMALL  
STONE / STEEL



HOOKED WALL / SMALL  
GRAPHITE / BRASS



HOOKED WALL / SMALL  
GRAPHITE / SMOKED BRONZE

## HOOKED WALL / SMALL

A wall light made from solid metal with matt rubber detailing. The base is finished in either *stone* or *graphite* powder coating. The pendant length can be adjusted to suit and hooked onto a solid metal hook. Can be fitted as standalone or connected to a us outlet box. This light looks great with our Punch Bulb/ Puck, sold separately.

[busterandpunch.us](http://busterandpunch.us)  
[info@busterandpunch.us](mailto:info@busterandpunch.us)

 **illuminations**  
425 Peachtree Hills Ave. NE #3 Atlanta, GA 30305  
404.876.1064 [sales@illumco.com](mailto:sales@illumco.com)

# BUSTER + PUNCH

LONDON

## HOOKED WALL / SMALL

**SPECIFICATIONS:**

E26 / 110-120V / Dry locations  
 Max 40W type A bulb  
 Bulb sold separately  
 1 x small shade  
 Suitable for both 3.5 and 4" junction boxes  
 Wall mount only  
 cULus approved

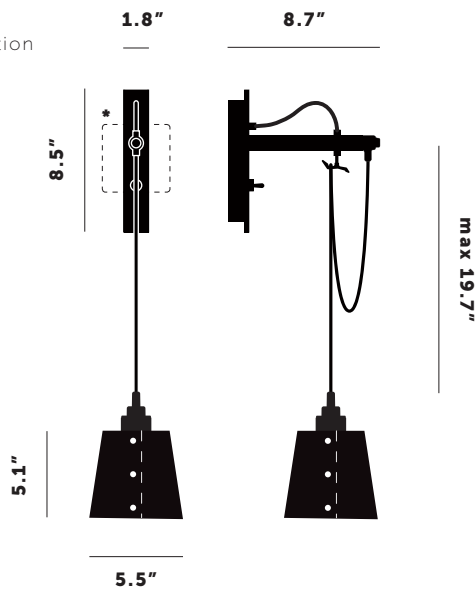

**FROM THE BACK:**

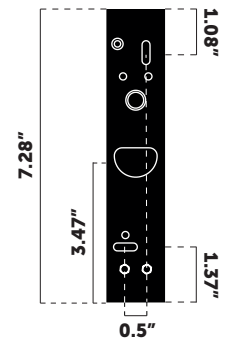

**US OUTLET BOX COVER PLATE:**

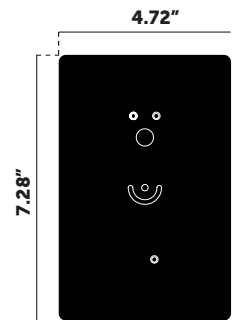

**FINISH**

-  Graphite / Steel
-  Graphite / Brass
-  Graphite / Smoked bronze
-  Stone / Steel
-  Stone / Brass
-  Stone / Smoked Bronze

**SKU**

- NHW-19516**
- NHW-18514**
- NHW-20515**
- NHW-23159**
- NHW-25517**
- NHW-24518**

**ALSO INCLUDED:**

- 1x us outlet box cover plate
- 1x bracket
- 1x coin cap installation tool\*
- 3x wire nuts

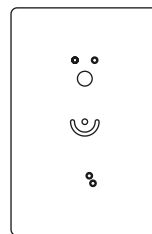

1 pc

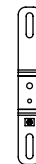

1 pc



1 pc

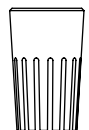

3 pcs

**CARE INSTRUCTIONS**

Wipe with damp cloth with no loose hairs, avoid using any chemicals. Please note all finishes are prone to aging.

\*Coin cap installation tool **must be used by hand only.**