

Name: Tibeta - Set 3

Design: Christophe Mathieu / 2015

Typology: Pendant lamp







Environment: Indoor

Technical description:

3 pendant linear fixture. Each pendant is made of spun aluminum available in Black Chrome with Black Fabric Cable and Black Canopy, Brilliant Copper with Copper Mesh Cable and White Canopy or Polished Aluminum with Grey Fabric Cable and White Canopy. Each pendant houses an LED plate diffused through opal glass.



Lamps description

 Grounding: compulsory
 30.4 W LED Led: 30.4 W LED Lumens: 2155 lm CRI: 80 Degrees Kelvin: 2900°-3200°
Voltage: 120V~60Hz
 1 Box 18.50 x 15.75 x 41.73 inches
Vol.: 7.0382 ft ³ Weight: 37.48 lbs
Certifications:  
 Photometrics made according to the position the lights are shown in the catalogue and price list.

Ref	Finishings
2570420107U	Black Chrome Black Fabric Wire Black Canopy
2570420164U	Polished Aluminum Grey Fabric Wire White Canopy
2570420190U	Brilliant Copper Copper Metallic Mesh White Canopy
Triac dimmable	
Not Customizable	

Measures

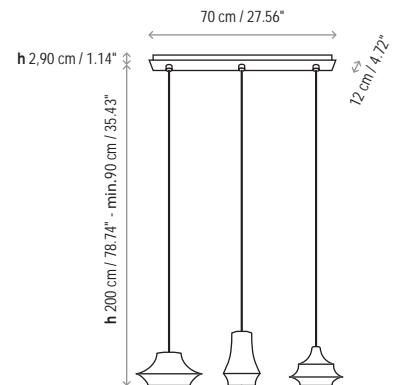

Tibeta - 01

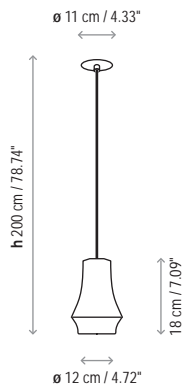

Tibeta - 02

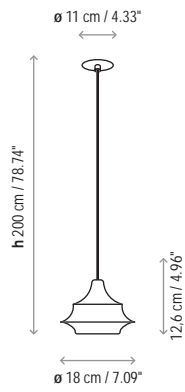

Tibeta - 03

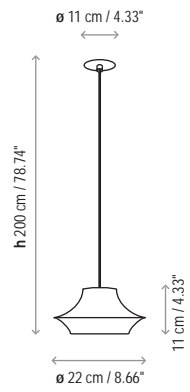

Tibeta - Set 3

