

Name: Nón Lá T

Design: Jorge Pensi Design Studio / 2015

Typology: Table lamp

Environment: Indoor

Technical description:

Lightweight asymmetrical conical LED table lamp made of aluminum finished in Chrome, Copper and White lacquer. Polycarbonate diffuser covering LED panel. Base of cast iron. Proxy dimmer switch under the lamp head.



Lamps description

Ⓢ 10,5 W LED
Led: 35 x 0.3 W = 10.5 W
Lumens: 1200 lm
CRI: 90
Degrees Kelvin: 2700°

Voltage: 120V~60Hz

📦 1 Box 16.14 x 14.17 x 20.87 inches

Vol.: 2.7616 ft³ Weight: 10.03 lbs

Certifications:  

 Photometrics made according to the position the lights are shown in the catalogue and price list.

Ref Finishings

3320130301U White Brilliant Lacquer

3320130306U Chrome

3320130390U Brilliant Copper

Proxy dimmer switch

Not Customizable

Measures

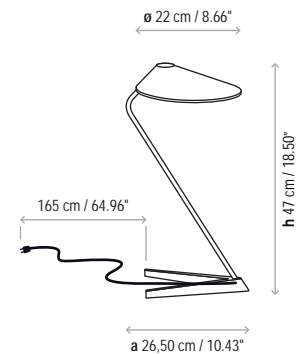

Nón Lá A 01

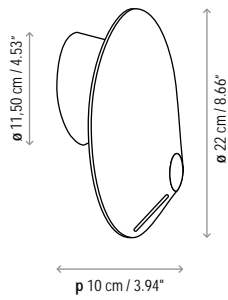

Nón Lá A 02

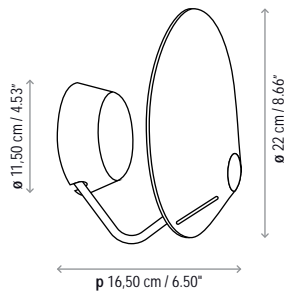

Nón Lá A 03

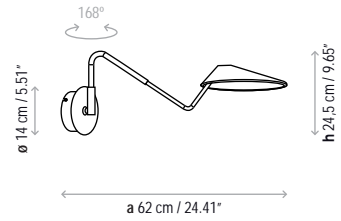

Nón Lá A 04

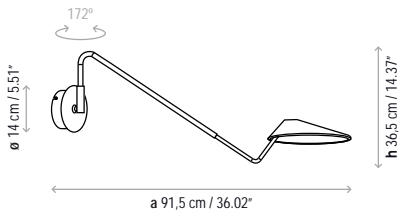

Nón Lá T

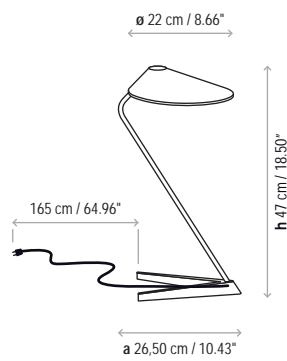

Nón Lá S

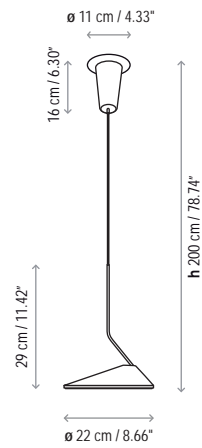

Nón Lá Set 3 Circular

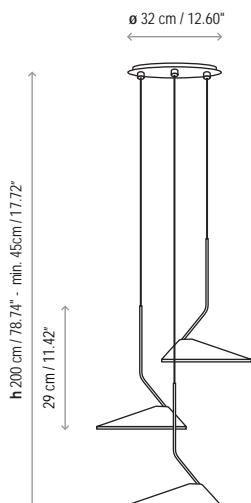

Nón Lá Set 3 Rectangular

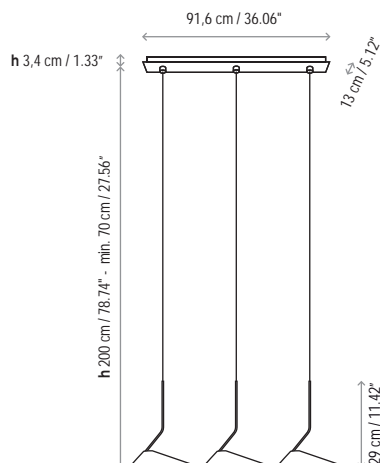

Nón Lá Set 6 Circular

