

Name: Drip A/03

Design: Christophe Mathieu / 2017

Typology: Wall Lamp

Environment: Indoor







Technical description:

Drip is an extensive family of luminaires designed for all types of applications, from residential & hospitality applications to retail and corporate.

The arm is in a fixed position. The fixture includes a USB port and a switch located in the structure below the tray. The glass can be cleaned with easy removal from the structure. It does not have screws. Water and non-abrasive soap can be used for cleaning and maintenance.



Lamps description

 Grounding: compulsory
 3 W LED Lumens: 345 lm CRI: 90 Degrees Kelvin: 2700°
Voltage: 120V~60Hz
 1 Box 12.60 x 12.60 x 25.98 inches
Vol.: 2.3873 ft <sup>3</sup>
Weight: 6.61 lbs / Net weight: 4.41 lbs
Fire Resistance: TB 117 : 2013 BS 5852 CRIB 5 BS 5852-1 PART I IMO RESOLUTION A.652 (16) EN 1021-1 EN 1021-2 UNI 9175 CLASSE 11M
Glow Wire Test: until 700°C Value: GWFI 700/1,23
Certifications:  
 Photometrics made according to the position the lights are shown in the catalogue and price list.

Ref                      Finishings

2590300738U	Transparent Glass
2590300739U	Frosted Glass
2590300781U	Green Glass
2590300786U	Blue Glass
Structure finish: Ebony black	
Borosilicate glass	
The inside of the tray includes a taupe coated fabric	
Weight capacity of the tray: 4.41 lbs	
USB port	
With switch	
IMPORTANT NOTE: Wall sconce product photography doesn't show US backplate mounting.	
Customizable	

Measures

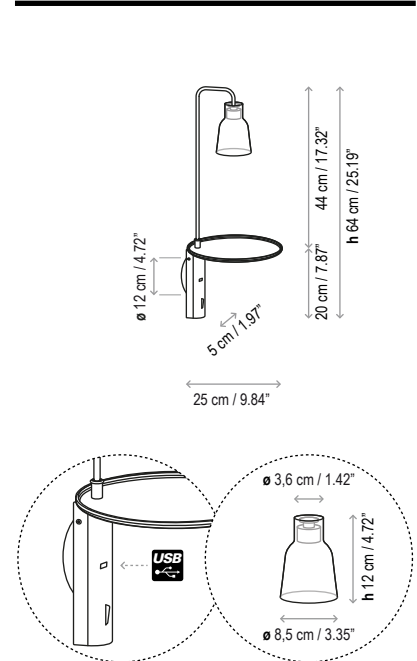

Drip A/01

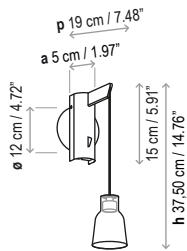

Drip A/02

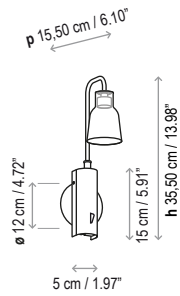

Drip A/03

