

PIPELINE CHANDELIER 12 – PENDANT

CAINE HEINTZMAN / 2019

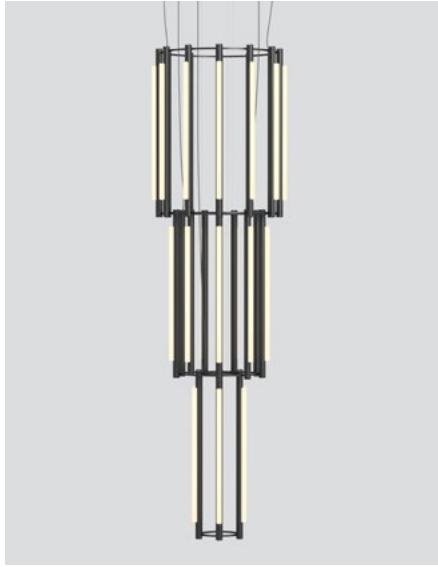

PIP-CHA-12-P-BK-27-ELV-120

DESCRIPTION

By definition, the Pipeline Chandelier features a cylindrical arrangement of linear illuminated sections cinched by metal hoops. Its carousel like form proposes an unconventional lighting solution, one that radiates and spreads from its concentric structure.

MATERIALS

- Aluminum Body
- Cast Acrylic

MANUFACTURED

Canada

DIMENSIONS

Ø1020 x 3750mm /
Ø40" x 148.5"

COLOUR TEMPERATURE

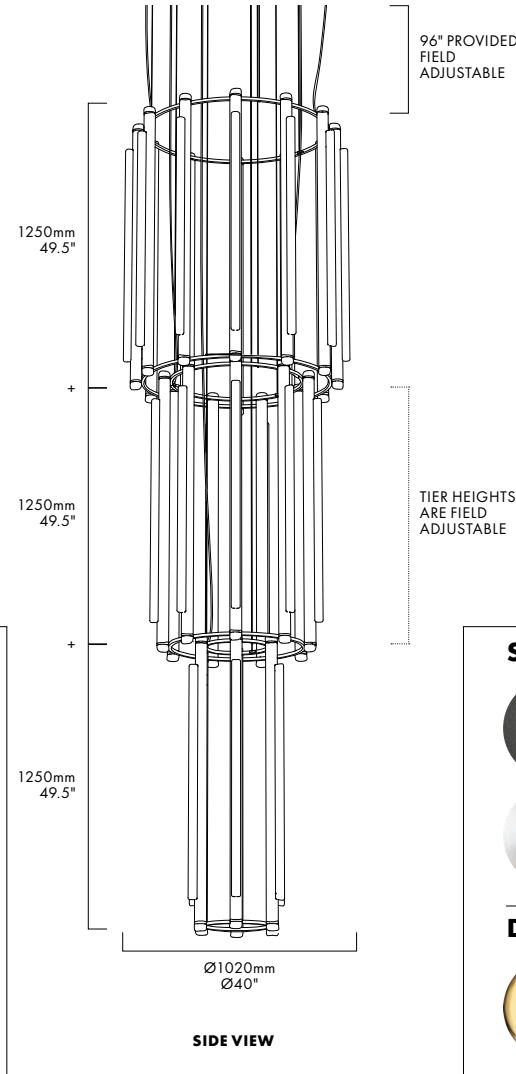
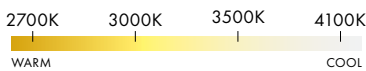

STANDARD FINISHES

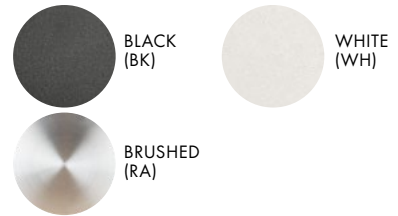

DECORATIVE FINISHES



ELECTRICAL

- 27 x 15W LED
- 47,000 hour Lifetime
- 90+ CRI
- Input Voltage 100–240V + 277V*

*only available with 0–10 power supply

- Integral 24V DC power supply included
- Dimming Options: ELV, 0–10, Dali

CERTIFICATIONS



SERIES	MODEL	TYPE	FINISH	CCT	PS	VOLTAGE IN
PIP	CHA-12	P	<input type="checkbox"/> BK (BLACK)	<input type="checkbox"/> 27 (2700K)*	<input type="checkbox"/> ELV*	<input type="checkbox"/> 120
			<input type="checkbox"/> WH (WHITE)	<input type="checkbox"/> 30 (3000K)	<input type="checkbox"/> 010	<input type="checkbox"/> 230
			<input type="checkbox"/> RA (BRUSHED)	<input type="checkbox"/> 35 (3500K)	<input type="checkbox"/> DAL	<input type="checkbox"/> 277**
			<input type="checkbox"/> 41 (4100K*)			
			<input type="checkbox"/> BR (BRASS)			
			<input type="checkbox"/> CP (COPPER)			

*STANDARD STOCK FOR 120V

**ONLY AVAILABLE 0–10 POWER SUPPLY

MODIFIED: 06/10/20



illuminations
+ 425 Peachtree Hills Ave. NE #3 Atlanta, GA 30305
404.876.1064 sales@illumco.com

PIPELINE CHANDELIER – PENDANT

1

2

3

4

5

6

ONE-TIER

PIP-CHA-1

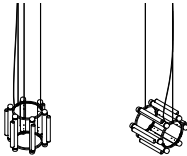

PIP-CHA-2

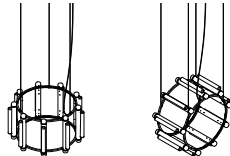

PIP-CHA-3

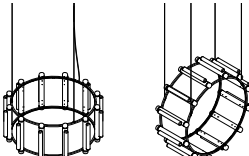

PIP-CHA-4

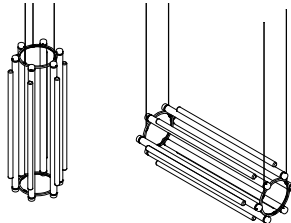

PIP-CHA-5

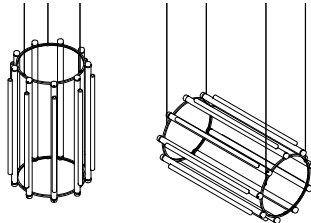

PIP-CHA-6

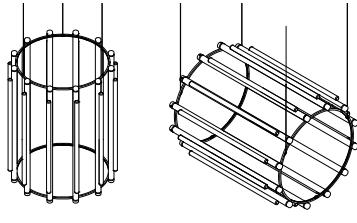

TWO-TIER

PIP-CHA-7

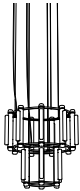

PIP-CHA-8



PIP-CHA-9

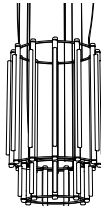

THREE-TIER

PIP-CHA-10



PIP-CHA-11

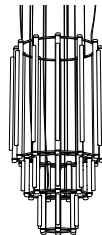

PIP-CHA-12



CUSTOM AVAILABLE

Pipeline Chandelier can be expanded further than the shown options. For custom arrangements and special projects, please contact info@andlight.ca

MODIFIED: 06/10/20

