

DIADEMA

Design Romani Saccani Architetti Associati

DIADEMA SP A M



Luce in movimento. È la sensazione che invade l'ambiente quando si accende una Diadema. Il lavoro di Romani Saccani Architetti Associati, padri di questo progetto, si concentra dapprima sul singolo elemento della canna di vetro in cristallo per poi svilupparsi su un sistema composto: combinando canne di diverse dimensioni, la luce si riflette e trasmette la dinamicità desiderata. Numerose le varianti e le possibilità di personalizzazione. Disponibile nelle versioni sospensione, plafoniera, applique, lampada da tavolo e lampada da terra. Tonalità del vetro in cristallo. Parti metalliche in finitura bronzo satinato e cromo.

DIADEMA SP A M

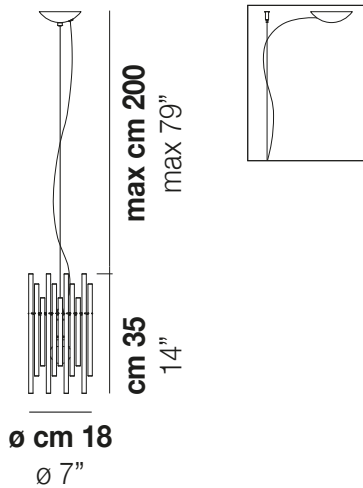

DATI TECNICI:



CERTIFICAZIONI:



SORGENTI LUMINOSE

1x75w 120V/60HZ E26

VOLUME Mc 0,06
PESO LORDO Kg 12
PESO NETTO Kg 6

download risorse



FINITURA DEL DIFFUSORE



CR

FINITURA MONTATURA

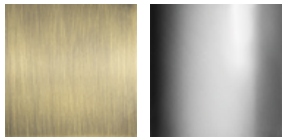

BS

CR

ALTRE VERSIONI DISPONIBILI

clicca sul disegno per accedere alla pagina web della relativa product sheet

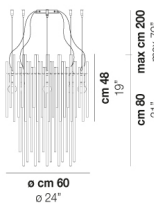

DIADE SP 60 B

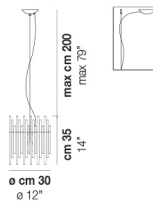

DIADE SP A G

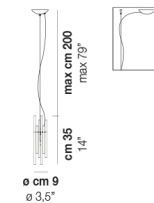

DIADE SP A P

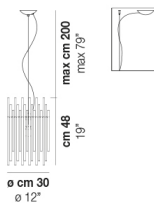

DIADE SP B G

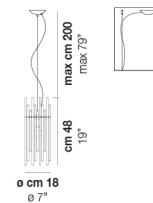

DIADE SP B M

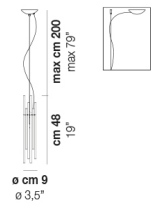

DIADE SP B P

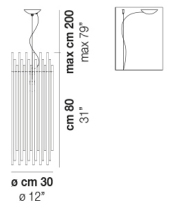

DIADE SP C G

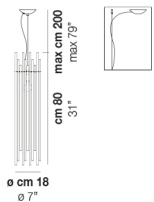

DIADE SP C M

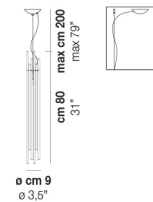

DIADE SP C P

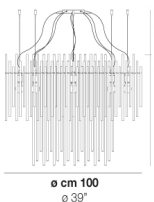

DIADE SP C

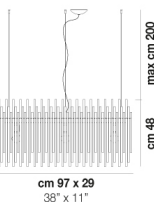

DIADE SP K3

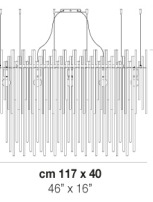

DIADE SP O2