

REF.

SAT SP LED DIM UL

LIGHT SOURCE



120 - 277V: Dimmable 0-10V & TRIAC

Driver:

Constant Current 700mA

LED Integrated:

Led module

2700K, CRI>90, 25W, 50-60Hz, 1782 lm*

4.000K, CRI>90, 25W, 50-60Hz, 2061 lm*

*Measurements obtained by photometric laboratory tests using ivory white shades. Veneer Ref: 20 Ivory White.

PACKAGING

Box Size: 24 x 24 x 13"

Box Volume: 4,5 ft³

Weight: Gross - 16,1 Lb | Net - 6,8 Lb

MATERIALS & COMPONENTS

Wood Veneer Shade

- White Top Diffuser

Black is available if you want no upward light diffusion

- Matt Satin Acrylic Bottom Diffuser











Nickel Metal Canopy: \varnothing 6,7"

3 Steel Cables: 8 ft drop

Transparent Electrical Cable: 8 ft drop

FINISHES

WOOD VENEER

- | | | | |
|---|-------------------|--|--------------|
|  | 20 Ivory White |  | 26 Red |
|  | 21 Natural Cherry |  | 28 Blue |
|  | 22 Natural Beech |  | 29 Grey |
|  | 24 Yellow |  | 33 Pale Rose |
|  | 25 Orange |  | 34 Sea Blue |

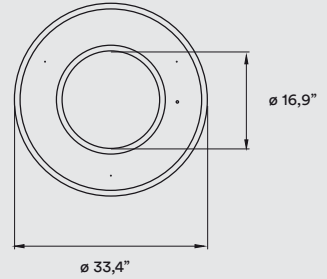
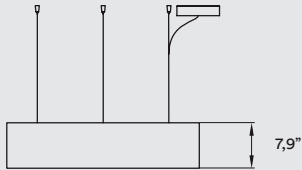

REF.

SAT SM LED DIM UL

LIGHT SOURCE



120 - 277V: Dimmable 0-10V & TRIAC

Driver:

Constant Current 1400mA

LED Integrated:

Led module

2700K, CRI>90, 57W, 50-60Hz, 4216 lm*

4.000K, CRI>90, 57W, 50-60Hz, 4777 lm*

*Measurements obtained by photometric laboratory tests using ivory white shades. Veneer Ref: 20 Ivory White.

PACKAGING

Box Size: 43 x 43 x 14"

Box Volume: 15,5 ft³

Weight | Gross: 36,6 Lb | Net - 17,4 Lb

MATERIALS & COMPONENTS

Wood Veneer Shade

- White Top Diffuser
Black is available if you want no upward light diffusion
- Matt Satin Acrylic Bottom Diffuser











Nickel Metal Canopy: \varnothing 6,7"

3 Steel Cables: 8 ft drop

Transparent Electrical Cable: 8 ft drop

FINISHES

WOOD VENEER

- | | | | |
|---|-------------------|--|--------------|
|  | 20 Ivory White |  | 26 Red |
|  | 21 Natural Cherry |  | 28 Blue |
|  | 22 Natural Beech |  | 29 Grey |
|  | 24 Yellow |  | 33 Pale Rose |
|  | 25 Orange |  | 34 Sea Blue |

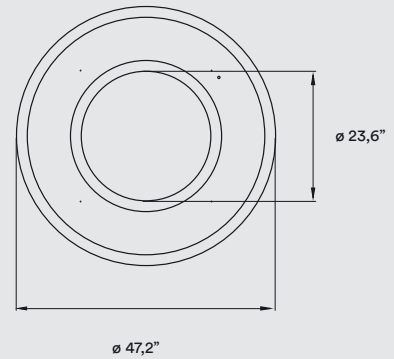
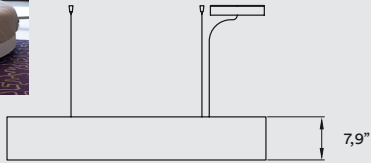

REF.

SAT SG LED DIM UL

LIGHT SOURCE



120 - 277V: Dimmable 0-10V & TRIAC

Drivers:

- Constant Current 1400mA
- Constant Current 700mA

LED Integrated:

Led module

2700K, CRI>90, 85W, 50-60Hz, 6325 lm*
4.000K, CRI>90, 85W, 50-60Hz, 7165 lm*

*Measurements obtained by photometric laboratory tests using ivory white shades. Veneer Ref: 20 Ivory White.

PACKAGING

Box Size: 55 × 55 × 15" - Wood crated for transport

Box Volume: 25,2 ft³

Weight | Gross: 121,9 Lb | Net - 33,7 Lb

MATERIALS & COMPONENTS

Wood Veneer Shade

- White Top Diffuser
Black is available if you want no upward light diffusion
- Matt Satin Acrylic Bottom Diffuser











Nickel Metal Canopy: ø 9,1"

4 Steel Cables: 8 ft drop

Transparent Electrical Cable: 8 ft drop

FINISHES

WOOD VENEER

- | | | | |
|---|-------------------|---|--------------|
|  | 20 Ivory White |  | 26 Red |
|  | 21 Natural Cherry |  | 28 Blue |
|  | 22 Natural Beech |  | 29 Grey |
|  | 24 Yellow |  | 33 Pale Rose |
|  | 25 Orange |  | 34 Sea Blue |