

# NANDO wall lamp

Dario De Meo and Luca De Bona design

year 2015

## TECHNICAL SHEET - AP109 2G INT

### STRUCTURE "A"

material metal  
colour charcoal-grey



### ELECTRICAL CABLE

socket E27  
source max 1x52  
energy class from E to A++





### PACKAGING

nr.of collis 1  
net weight/kg 1,2  
gross weight/kg 1,5  
packaging/cm 21x21x20

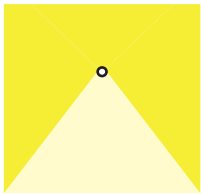
### EMISSION OF LIGHT

one directional



 direct  
 filtered  
 indirect  
 none

### CERTIFICATION

IEC 60598-1:2008  
EN 60598-1:2008 + A11:2009



IP rate IP20  
bulb optional



code **700L**  
decorative bulb  
E27 - 25w - ≤ 60 lumen  
class E

these items are special, decorative bulbs not for illuminatin purposes

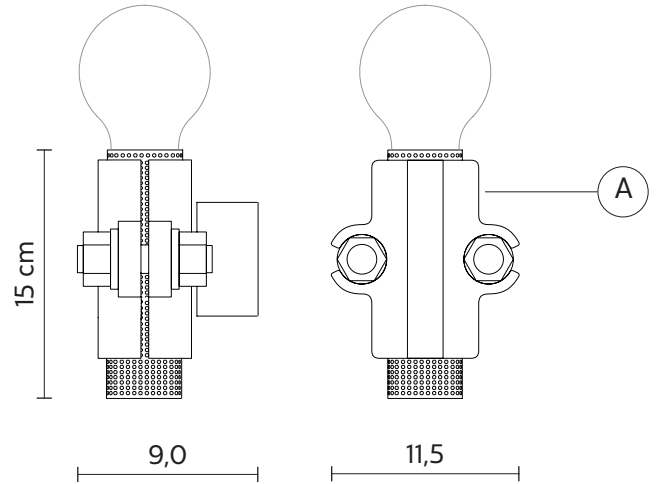

### COLLECTION

available also as: suspension

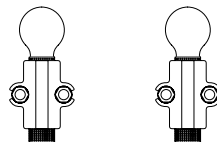

AP1092BINT

AP1092OINT

  
425 Peachtree Hills Ave. NE #3 Atlanta, GA 30305  
404.876.1064 sales@illumco.com