

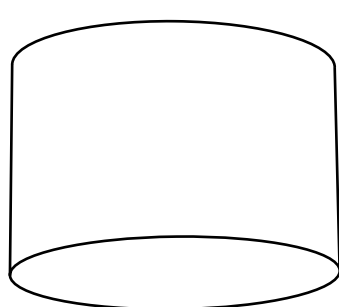

Ceiling Round

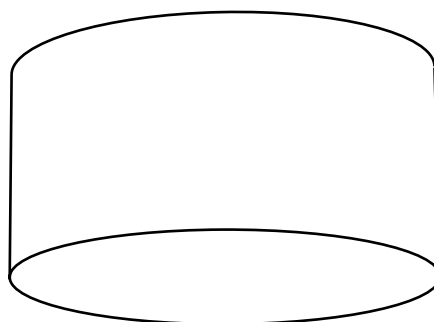

18 x 11.8



23.6 x 11.8

Sizes in (DxH)

All our round shades can be used with our CME ceiling mounted fitting and will have a 6cm gap between the shade and the ceiling.

We do however make these 2 sizes to be flush to the ceiling if height is critical.

Diffusers for ceiling mounted shades will have a small hole to aid installation.



illuminations

425 Peachtree Hills Ave. NE #3 Atlanta, GA 30305
404.876.1064

sales@illumco.com

CME

We designed our CME ceiling fitting to enable lampshades to be used in spaces with low ceiling heights. There is just a 6cm gap between the shade and the ceiling when used with our standard round shades. For those that prefer the shade flush with the ceiling we have 2 standard sizes for this, see page 55 for details.

Diffusers for shades used with this fitting come either in expanded white vinyl or clear prismatic acrylic and have a small central hole to aid installation. In addition, the 20cm glass globe diffuser can be used with this fitting.

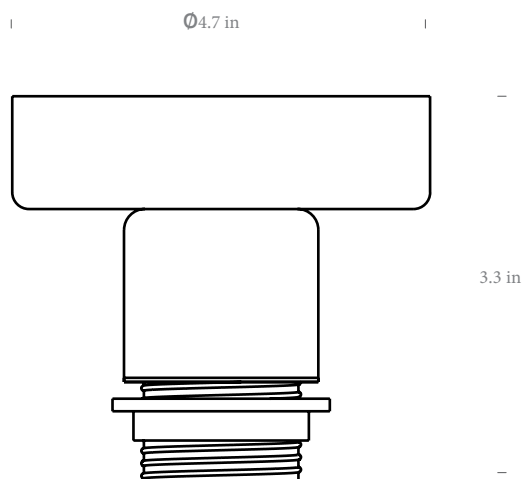

Materials : Stainless Steel

Colour : White / Satin Nickel

Lightsource : E27 Max 15W LED (not included)

Recommended Bulb : LED bulbs 400 - 1000 lumen output and from 2700K

USA Spec available on request

Innermost recommends:

Pair with a diffuser to complete the shade for best effect.



illuminaTions

425 Peachtree Hills Ave. NE #3 Atlanta, GA 30305
404.876.1064 sales@illumco.com



Telford

Polyester

Our most versatile fabric, Telford, name after our home town, is available in 20 colours and looks great on all shapes and sizes.



Suitable for all shade shapes and sizes, see page 4 for details.

Materials : Woven Polyester

Acoustic Absorbancy : ●●○○○

Price category : A

Innermost recommends:

The ideal fabric for mixing and matching multiple colours.



Harrogate

Quilted velvet

Add some luxury to your interior with these beautiful velvets available in five different coloured quilted patterns. The sumptuous quilting makes these fabrics extra thick and soft.

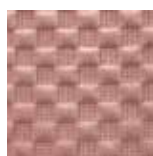

Pink
Square



Grey
Rectangles

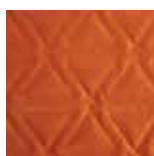

Burnt Orange
Triangles



Blue
Waves



Chocolate
Tristar

Suitable for all Drum shapes
Materials : Quilted velvet
Acoustic Absorbancy : ●●●●●●
Price category : C

Innermost recommends:
Complete your pendant with a cotton diffuser.



Stafford

Polyethylene

This contemporary collection is taken from the world of contract wall-coverings. These earthy textural woven materials suit a natural colour palette.

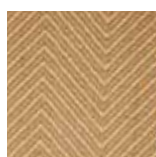

Herringbone
Tan

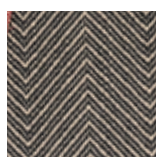

Herringbone
Black

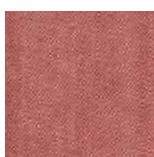

Red

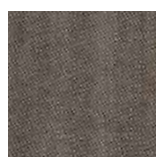

Black



Dark Red



Blue

Suitable for all shade shapes and sizes, see page 4 for details.

Materials : Woven Polyester

Acoustic Absorbancy : ●●●●●

Fire Rated, Wipeable, Anti bac and Marine

Price category : C

Innermost recommends:

Being wipeable, Stafford is perfect for lampshades where cle



illumination

425 Peachtree Hills Ave. NE #3 Atlanta, GA 30305
404.876.1064

sales@illumco.com



Wenlock Wool felt

A soft natural wool felt in rich colours to bring added warmth to any interior.



Natural



Orange

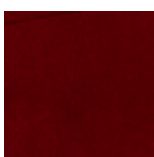

Red

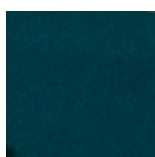

Ocean Blue

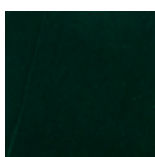

Dark Green



Navy



Charcoal

Suitable for all shade shapes and sizes, see page 4 for details.

Materials : Wool felt

Acoustic Absorbancy : ●●●●○

Price category : D

Innermost recommends:

Works well for both ceiling and table lamps to add texture to



illuminaitions

425 Peachtree Hills Ave. NE #3 Atlanta, GA 30305
404.876.1064

sales@illumco.com



Creation Baumann Polyester

Création Baumann have been weaving world-renowned fabrics in Switzerland since 1886. We made this selection from their Arik collection as we believe they make great contemporary lampshades that will complement any interior. The fabric has a two-tone micro-pattern which results in an interplay with up to three colour nuances depending on the angle of vision.

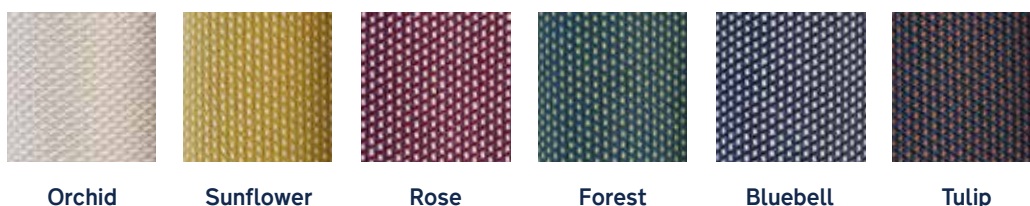

Orchid

Sunflower

Rose

Forest

Bluebell

Tulip

Suitable for all shade shapes and sizes, see page 4 for details.

Materials : Polyester

Acoustic Absorbancy : ●●●●●●

Price category : F

Innermost recommends:

Works best on large round & donut pendant and ceiling shapes.



Colefax Indra

Viscose polyester acrylic

A lustrous textured fabric from the British fabric house Colefax & Fowler that uses a satin warp and strong woven textures to achieve the effect of hammered metal. Polished and sleek, we have it as standard in 3 burnished tones of Copper, Teal and Silver.



Silver

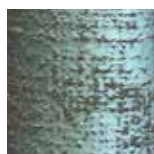

Teal

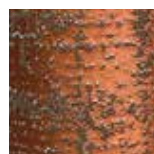

Copper

Suitable for all shade shapes and sizes, see page 4 for details.

Materials : Viscose Polyester Acrylic

Acoustic Absorbancy : ●●●●●●

Price category : G

Innermost recommends:

The sheen of these shades are perfect for adding sophisticated and low-key luxury.

 **illuminaTions**

425 Peachtree Hills Ave. NE #3 Atlanta, GA 30305
404.876.1064

sales@illumco.com