



Product Specification Sheet

BuzziMoon 120-277V

— By BuzziSpace Studio

Embedded light

BuzziMoon offers the best of both worlds; highly functional general lighting embedded in a proven acoustic ceiling solution. One of the first acoustical lighting solutions that is equally performant on lighting as on acoustic level. The LED light module is designed specifically to answer the request of general lighting in office space. The Moon can be finished off in different fabrics and various 3D patterns. The diffuser gives it a “full moon” lighting experience. BuzziMoon is equally available in EU and US.



The Family

Models

BuzziMoon Round

BuzziMoon Oval

Lighting Unit

LED Disk
Ø 470

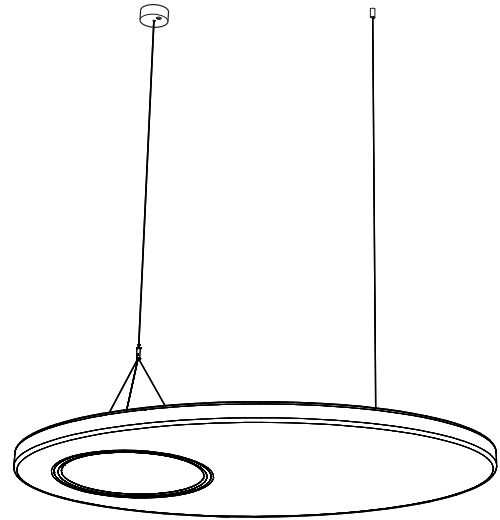
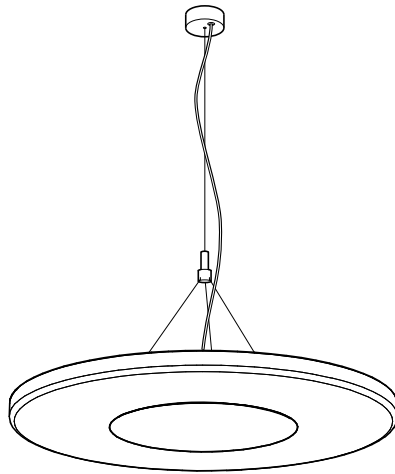

Required order information

1. Model
2. Size
3. Pattern
4. Fabric (CAT -> Collection -> Color)

Lighting Data

Lighting Unit

LED Disk Ø 470



The PMMA diffuser ensures an optimal light spread and efficiency. It creates a very diffuse light surface without any dottiness. The light source of the BuzziMoon is a LED PCB, containing 36 low power LED's.

Lighting specifications

BuzziMoon Round S | M | L

Lighting Unit	Voltage	Wattage	Light Output Luminaire	Efficacy (lm/W)	CRI	Dimming	Color Temperature	UGR	Standard (stock) On request (>LT)	Color Power Cable	Color Ceiling Canopy	Pattern	Fabric Collection	Fabric Color	Mounting Option
LED Disk Ø470	120-277V	35W	2545 Lm	73	90	1-10V	3000K	22	Standard	Transparent	White	Flat, 3D Rib, 3D Drop, 3D Leaf	Use color codes below	Use color codes below	Split cables of 157.48" in Alu, Ceiling Mounted

BuzziRound Oval S | M

Lighting Unit	Voltage	Wattage	Light Output Luminaire	Efficacy (lm/W)	CRI	Dimming	Color Temperature	UGR	Standard (stock) On request (>LT)	Color Power Cable	Color Ceiling Canopy	Pattern	Fabric Collection	Fabric Color	Mounting Option
LED Disk Ø470	120-277V	35W	2545 Lm	73	90	1-10V	3000K	22	Standard	Transparent	White	Flat, 3D Rib, 3D Leaf	Use color codes below	Use color codes below	Split cables of 157.48" in Alu



cULus listed

Product Data

Fixing System

Fixing System BuzziMoon Round Ceiling Mounted

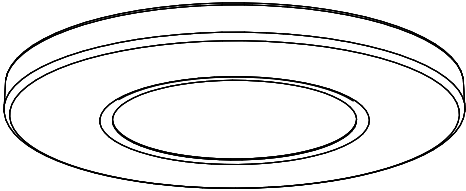

Fixing System BuzziMoon Round Ceiling Suspended Split

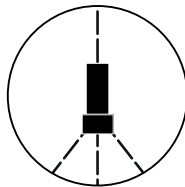
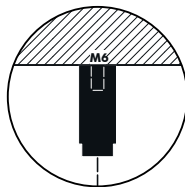
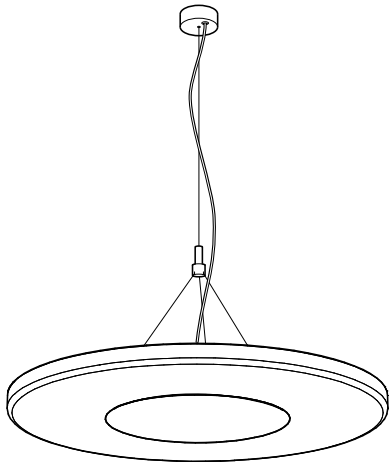

Fixing system with 3 split cables with 1 main cable, total length of 157.48" (alu).
Min distance of shade to ceiling is 19.7"

Fixing System BuzziMoon Oval Ceiling Suspended Split

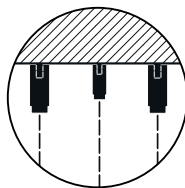
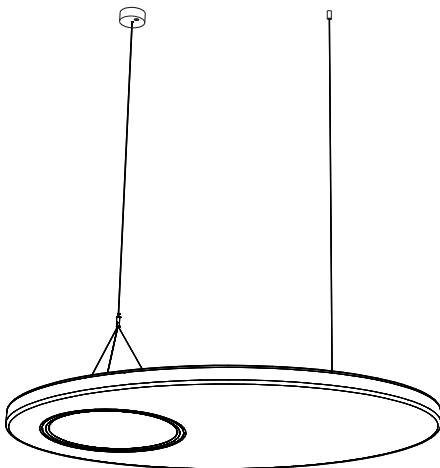

Fixing system with 3 split cables with 1 main cable and 1 additional cable, total length of 157.48" (alu).
Min distance of shade to ceiling is 19.7"

▲ If installing on suspended ceiling, verify load capacity prior to installation.

Acoustic Panel



The acoustic panel is upholstered top to bottom in a chosen fabric



Absorption



Diffusion



Mid tone



High tone



High tone

Patterns Oval

Flat

M

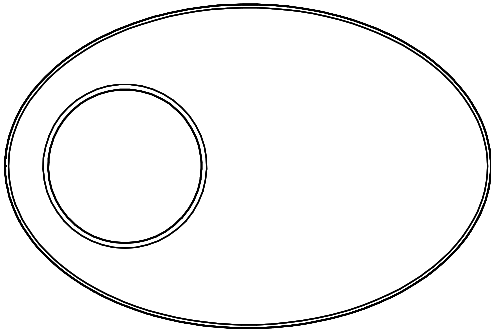

S

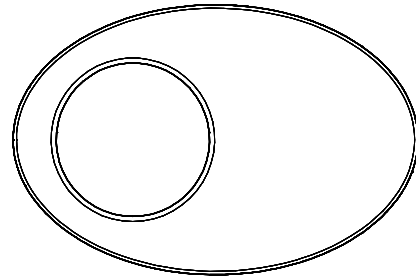

3D Leaf

M

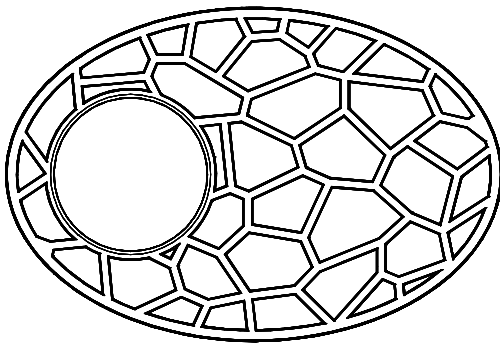

S

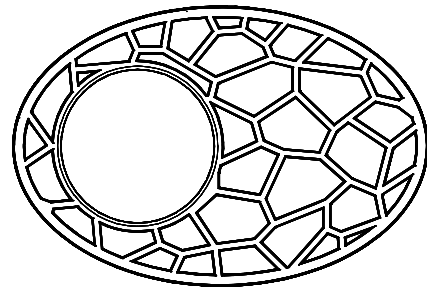

3D Rib

M

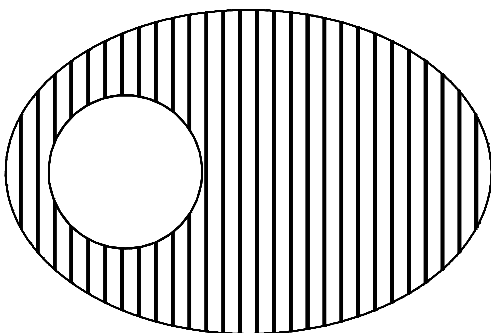

S

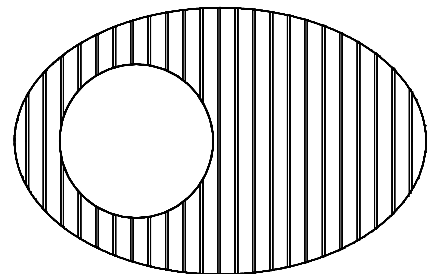

Acoustic Panel Oval

M

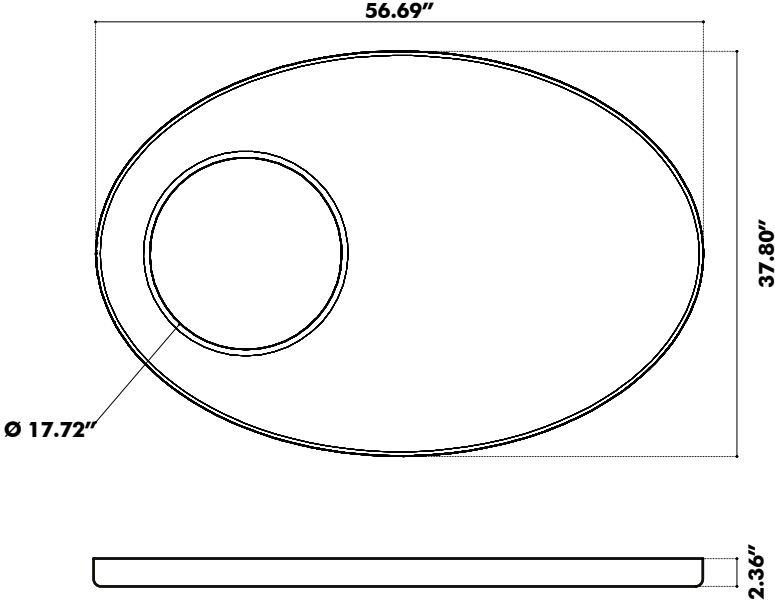

S

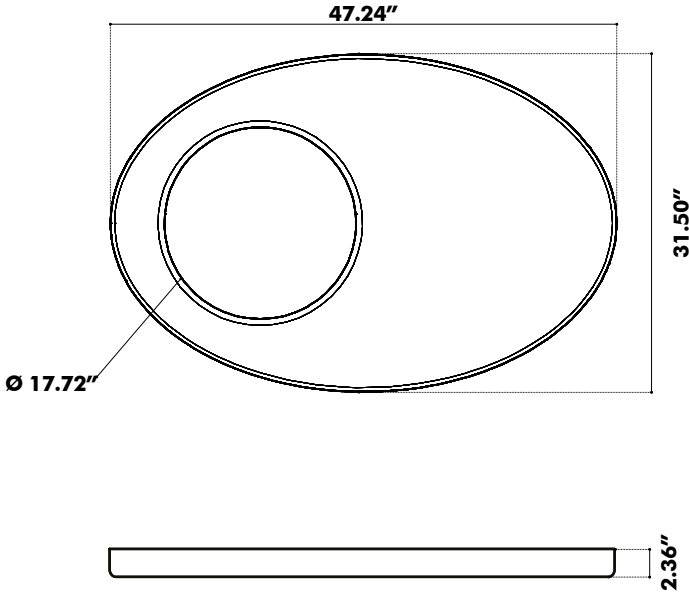

Suspension Set Oval

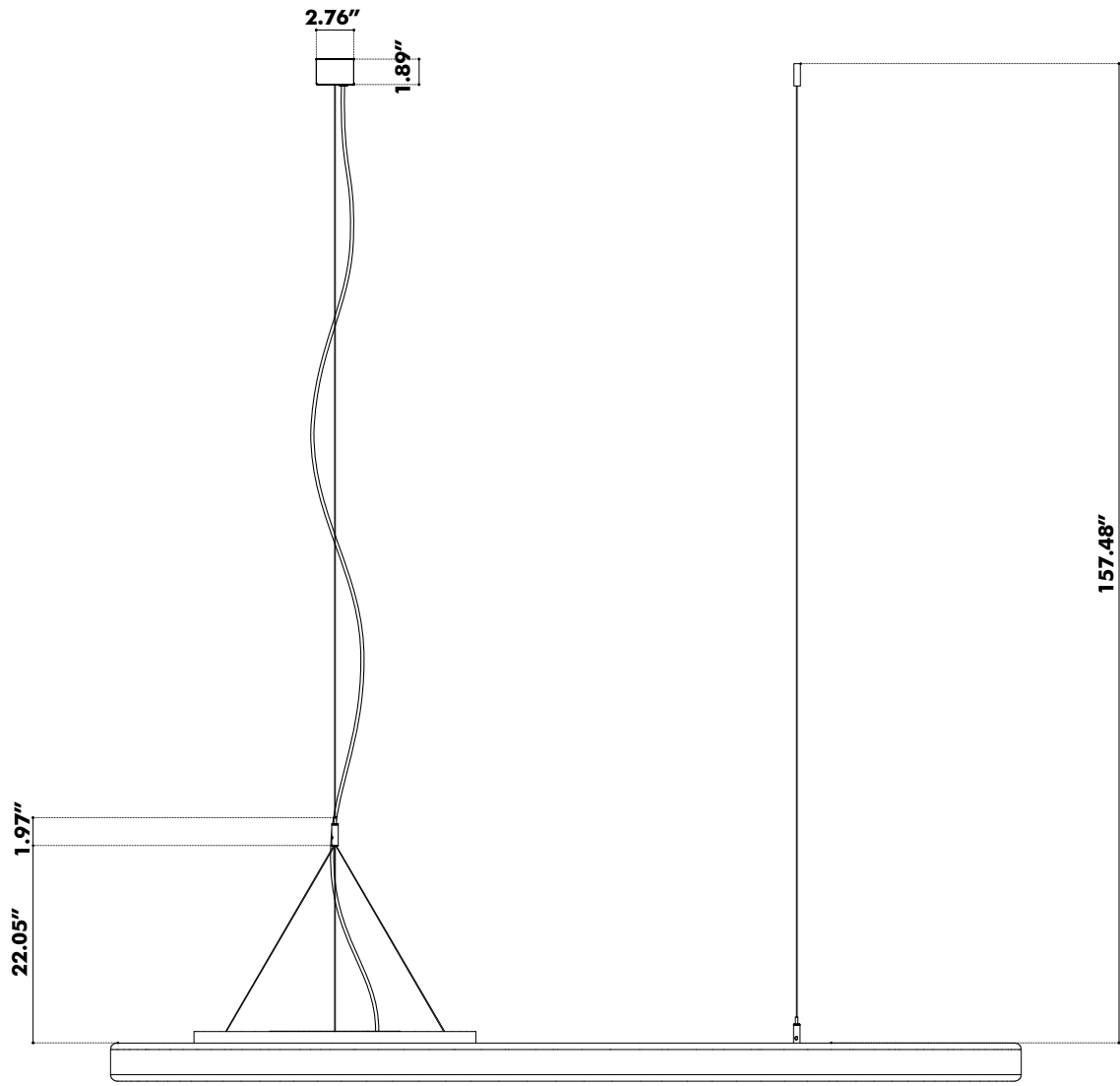

Fabrics

Fabric (45 colors)

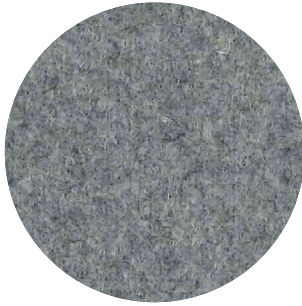

Category A

Composition 70% Recycled Wool, 25% Recycled Polyacryl,
5% Recycled Other Fabrics

Weight 405 g/m² | 11.94 oz/yd²

Abrasion resistance 40.000 Martindale, 50,000 Wyzenbeek

Flammability EU: EN 1021.1/2006 | BS EN 1021.1/2006 (cigarette).
EN 1021.2/2006 | BS EN 1021.2/2006 (match)
USA: CAL TB 117 | ASTM E84 CLASS A

Fastness to light EU: 4 | USA 4

Fastness to rubbing EU: Wet 3-4 | Dry 4-5

Fastness to crocking USA: Wet 5 | Dry 5



Trevira CS+ | CS (47 colors)

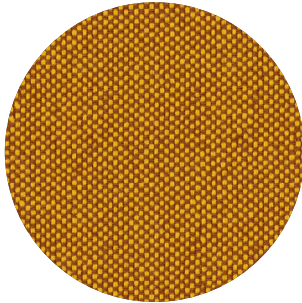

Category A

Weight 420 g/m² | 12.39 oz/yd²

Composition 100% Polyester, Trevira CS

Abrasion resistance 100.000 Martindale, 90,000 Wyzenbeek

Flammability BS 5852 part II: CRIB 5 | BS 7176 Medium Hazard
USA: CAL TB 117 | M1 | B1 | EN 1021/1-2 | C1 |
IMO Res. A652 (16)

Fastness to light EU: 6 | USA 5

Fastness to rubbing EU: Wet 4-5 | Dry 4-5

Fastness to crocking USA: Wet 5 | Dry 5



Revive 1 (25 colors)

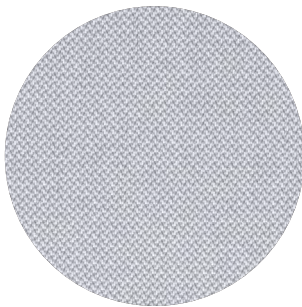

Category A

Composition 100% recycled polyester FR

Weight 430 g/lin.m

Abrasion resistance 60.000 Martindale rubs, EN ISO 12947

Flammability EN 1021-1/2 | DIN 4102 B1 | Önorm B1/Q1
UNI 9175 11M | US Cal. Tech. Bull. 117
IMO A.652 (16)

Fastness to light Note 5-7, ISO 105-B02

Fastness to rubbing (ISO) dry 5, wet 4-5

Pilling Note 4-5, EN ISO 12945



kvadrat

Clara 2 (24 colors)

kvadrat

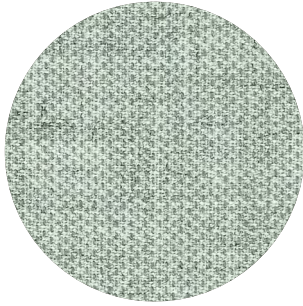

Category B

Composition 92% new wool, 8% nylon

Weight 400 g/lin.m

Abrasion resistance 80.000 Martindale rubs, EN ISO 12947

Flammability EN 1021-1/2 | BS 5852, ignition source 2-3 | DIN 4102 B2
NF D 60 013 | UNI 9175 11M | US Cal. Tech. Bull. 117, Sec. E
NFP A 260 | IMO A.652(16)

Fastness to light Note 5-7, ISO 105-B02

Fastness to rubbing (ISO) dry 4-5, wet 4

Pilling Note 4, EN ISO 12945



Remix 3 (73 colors)

kvadrat



Category B

Composition 90% new wool, 10% nylon

Weight 415 g/lin.m

Abrasion resistance 100.000 Martindale rubs, EN ISO 12947

Flammability EN 1021-1/2 | BS 5852 part 1
Önorm B1/Q1 | NF D 60 013 | UNI 9175, 11M
AS/NZS 1530.3 | Cal. Tech. Bull. 117-2013
NFP A 260 | IMO FTP Code 2010:Part 8

Fastness to light Note 5-7, ISO 105-B02

Fastness to rubbing (ISO) dry 4-5, wet 4

Pilling Note 4, EN ISO 12945



Hero 2 (33 colors)

kvadrat

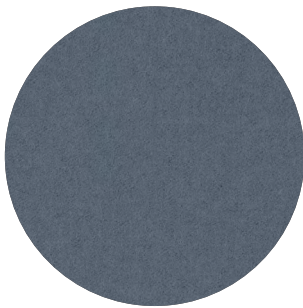

Category C

Composition 97% new wool, 3% nylon

Weight 580 g/lin.m

Abrasion resistance 45.000 Martindale rubs, EN ISO 12947

Flammability EN 1021-1/2 | DIN 4102 B2 | NF D 60 013
UNI 9175 11M | US Cal. Bull. 117-2013 | NFP A 260
IMO A.652 (16)

Fastness to light Note 5-6, ISO 105-B02

Fastness to rubbing (ISO) dry 4-5, wet 4-5

Pilling Note 3-4, EN ISO 12945



Tonus 4 (47 colors)

kvadrat



Category D

Composition 90% new wool, 10% Helanca

Weight 665 g/lin.m

Abrasion resistance 100.000 Martindale rubs, EN ISO 12947

Flammability EN 1021-1/2 | BS 5852 part 1 | DIN 4102 B2
Önorm B1/Q1 | NF D 60 013 | UNI 9175 11M
US Cal. Bull. 117-2013 | NFP A 260 | IMO A.652 (16)

Fastness to light Note 5-7, ISO 105-B02

Fastness to rubbing (ISO) dry 3-5, wet 3-5

Pilling Note 3, EN ISO 12945



Memory 2 (20 colors)

kvadrat

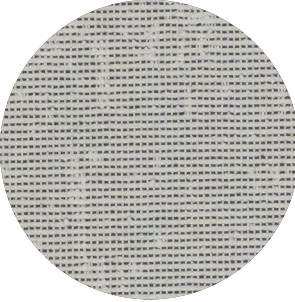

Category E

Composition 100% Trevira CS

Weight 700 g/lin.m

Abrasion resistance

35.000 rubs acc. to the Martindale method, EN ISO 12947

Flammability EN 1021-1/2 | DIN 4102 B1 | Önorm B1/Q1
NF D 60 013 | NF P 92 507 M1 | UNI 9175 11M
UNI 9177 classe 1 | US Cal. Tech. Bull. 117
IMO A.652 (16)

Fastness to light Note 5-8, ISO 105-B02

Fastness to rubbing (ISO) dry 4-5, wet 4-5

Pilling Note 4, EN ISO 12945

