



## Product Specification Sheet

### BuzziChandelier 120V

— By Sas Adriaenssens

#### An eye-catching lighting solution

Make a statement with your lighting by opting for the BuzziChandelier. A contemporary take on the classic chandelier. The perfect way to add atmosphere to your room with artful shadows and softened sounds. BuzziChandelier is an ideal design statement and acoustical solution for offices, restaurants, hotels, institutions, residences and more.



# The Family

## Models

**BuzziChandelier**

**BuzziChandelier Plain**

Lighting Units

**Retrofit bulb**  
(bulb excluded)

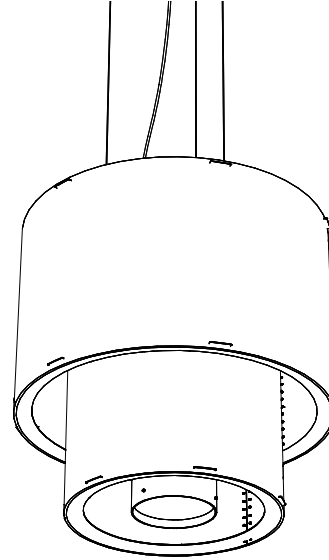
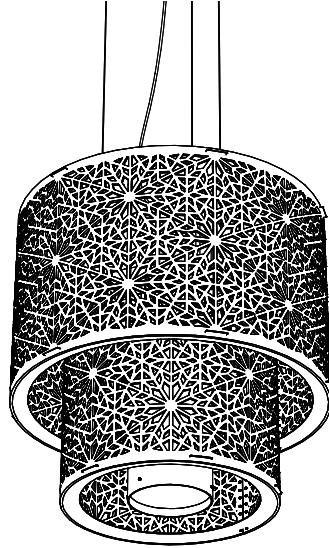

---

Required order information

1. Model
2. Color BuzziFelt or Pattern BuzziFelt Printed
3. Mounting Option

# Lighting Data

---

## Lighting Units

### Retrofit Lighting unit



Retrofit Bulb 2G11 excluded Max 40W CFL or  
Max 40W self ballasted LED in compliance with  
UL1993

# Lighting specifications

## BuzziChandelier | BuzziChandelier Plain

| Lighting Unit            | Voltage | Wattage   | Light Output Luminaire | Efficacy (Lm/W) | CRI | Dimming | Color Temperature | UGR | Standard (stock) On request (> LT) | Color Power Cable | Color Ceiling Canopy | Color Metal Frame | Fabric Collection     | Fabric Color          | Mounting Option                            |
|--------------------------|---------|-----------|------------------------|-----------------|-----|---------|-------------------|-----|------------------------------------|-------------------|----------------------|-------------------|-----------------------|-----------------------|--|
| Retrofit 2G11 bulb excl. | 120V    | Max. 40 W | -                      | -               | -   | -       | -                 | -   | Standard                           | Black             | Black                | Black             | Use color codes below | Use color codes below | 3 cables of 78,74" or 196,85" Alu or Black |



cULus listed

# Product Data

## Fixing System

### Fixing System Acoustic Panel

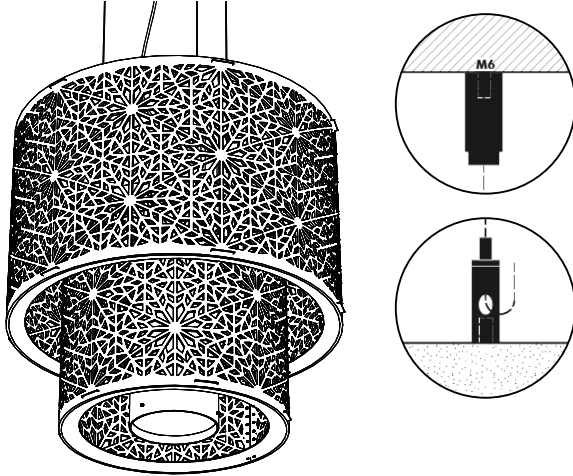

BuzziChandelier is suspended on 3 cables of 78.74" or 196.85" black or alu colored cables, with fixing system screw.

⚠ If installing on suspended ceiling, verify load capacity prior to installation.

## Acoustic Shade



The acoustic shade consists of one layer of BuzziFelt with push snaps.

Shade in BuzziFelt or Offwhite BuzziFelt Printed (outside) in Gold, Emperador or Carrara.



Absorption



Diffusion



Mid tone



High tone

# Dimensions

## BuzziChandelier

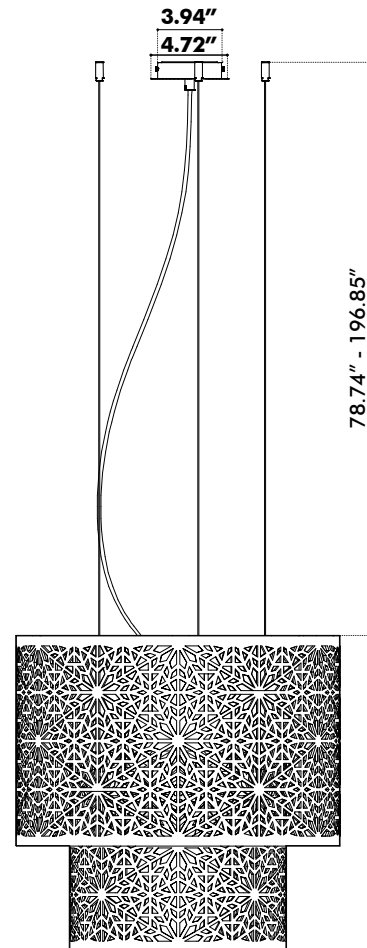
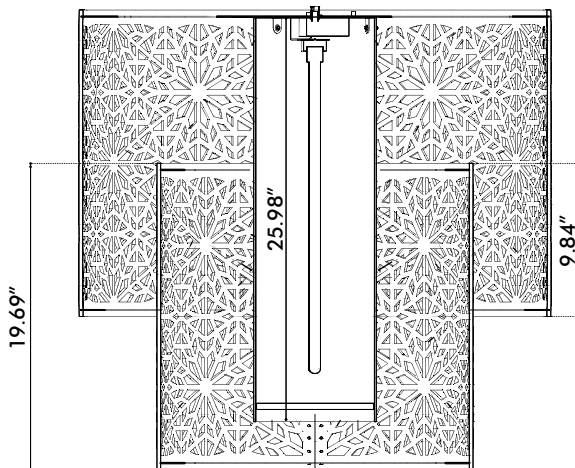
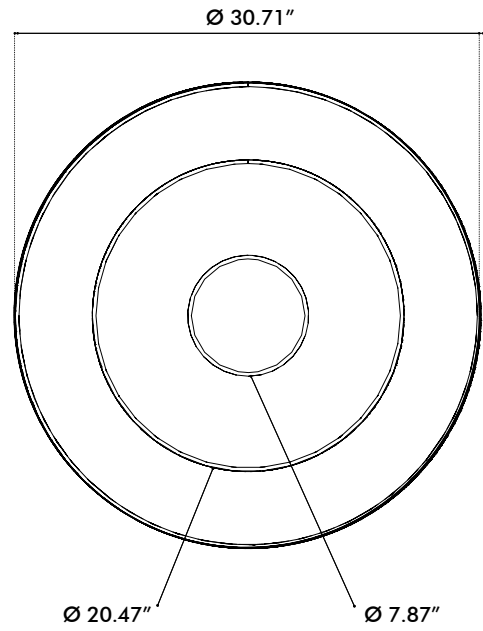
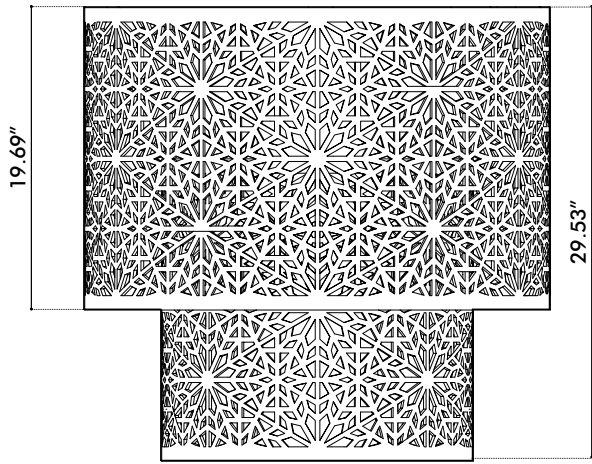

# Fabrics

---

## Felt (12 colors)

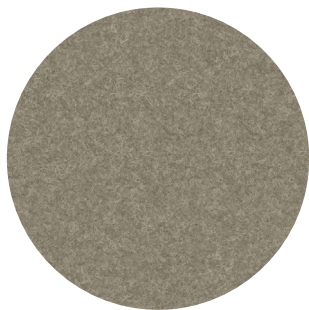

**Composition** 100% Recycled PE.T. Felt  
**Weight** 1.000 g/m2 | 29.49 oz/yd2  
**Abrasion resistance** >7.000 Martindale  
**Flammability** EU: EN 13501.1+A1/2009  
BS476 Part 6 and 7 Class 0  
USA: ASTM E84 Class A certified  
**Fastness to light** USA 5



## Felt OffWhite Printed

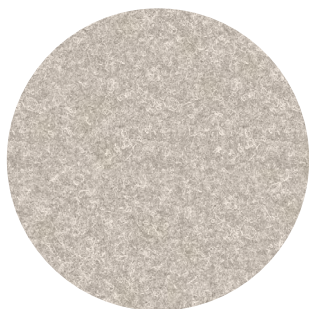

**Composition** 100% Recycled PE.T. Felt  
**Weight** 1.000 g/m2 | 29.49 oz/yd2  
**Abrasion resistance** >7.000 Martindale  
**Flammability** EU: EN 13501.1+A1/2009  
BS476 Part 6 and 7 Class 0  
USA: ASTM E84 Class A certified  
**Fastness to light** USA 5



Gold

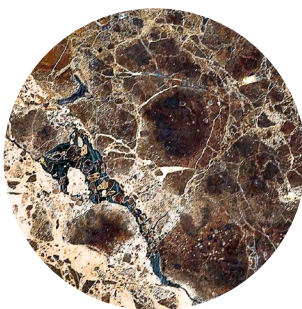

Emperador



Carrara