

Name: Garota - P / 02

Design: Alex Fernández Camps / Gonzalo Milà / 2015

Typology: Outdoor floor

Environment: Outdoor







Technical description:

Tall outdoor floor lamp with a tripod stand structure made of stainless steel, painted and cataphoresis treated that can withstand exposure to the elements. Lamp shade is composed of hand wrapped polyethylene synthetic fiber over aluminum frame, available in different colors. Light source is protected by a frosted, polyethylene globe of medium density and UV protection. Electrical cord is protected with water-proof neoprene coating, and fixture is

direct cord + plug with no switch on the cord or fixture. Available in Brown or Ivory finishes. Garota is not a customizable product. Consult for fastening options.



Lamps description

 Grounding: compulsory
 2 x 20 W E26 Triple CFL
 2 x 10 W E26 A19 LED
Voltage: 120V~60Hz
 1 Box 34.25 x 34.65 x 55.51 inches
Vol.: 38.1222 ft ³ Weight: 37.57 lbs
Certifications:   IP-55
 Photometrics made according to the position the lights are shown in the catalogue and price list.

Ref	Finishings
3350230001U	Natural White
3350230003U	Brown Graphite
P-801	Ivory White
P-802	Brown
All Bover's synthetic fiber collection are recyclable and non-toxic for environmental sustainability.	
Stainless steel structure, cataphoresis treatment and outdoor paint.	
Consult for floor fastening options.	
Height non customizable.	
Dry + wet location	
Not Customizable	

Measures

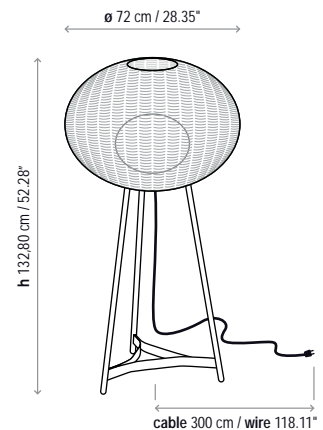

Garota - A / 01

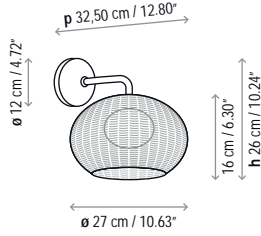

Garota - PF / 01

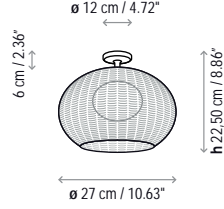

Garota - PF / 02

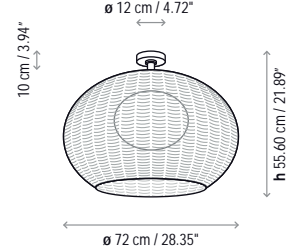

Garota - Hang

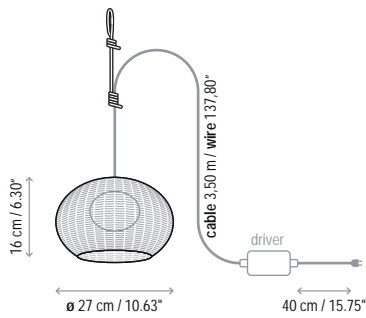

Garota - S / 01

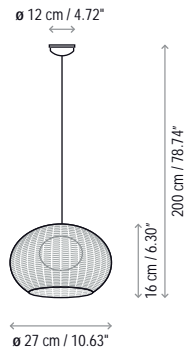

Garota - S / 02

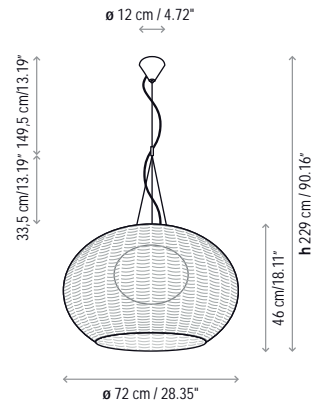

Garota - Mini

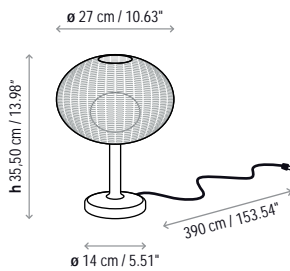

Garota - P / 01

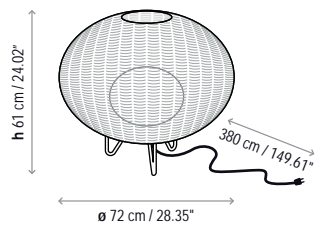

Garota - P / 02

